

Challenges & Changes

TUNNELLING ACTIVITIES IN JAPAN 2016



Reproduction or translation of all or any part of this publication is permissible if such is undertaken in connection with the advancement of the state-of-the-art or technology of tunnelling.

Should you require further details on these articles or other information on tunnelling activities in Japan, please contact:

Japan Tunnelling Association

Tsukiji MK Bldg., 11-26, Tsukiji 2-chome, Chuo-ku, Tokyo, 104-0045, Japan
TEL: (+81)-3-3524-1755 FAX: (+81)-3-5148-3655

E-mail: jta@japan-tunnel.org
<http://www.japan-tunnel.org>

JAPAN TUNNELLING ASSOCIATION

PREFACE

I feel really privileged to be given this opportunity to address tunnel engineers throughout the world on the occasion of the publishing of the 2016 edition of Tunnelling Activities in Japan, the biennial publication of the Japan Tunnelling Association. Despite the fact that in recent years tunnel construction projects in Japan are on the downturn, our country remains one of the outstanding global leaders in terms of tunnel construction volume.

The Japan Tunnelling Association was founded in August of 1975 and will celebrate its 40th anniversary in 2016. During this time, the increase in demand for tunnel construction and the progress of technology has been remarkable. Efforts to improve the efficiency and cost-effectiveness of tunnel construction have led to steady development of various types of tunneling technologies, bringing about current developments. In recent years, in order to contribute to economic activity and regional interchange, big projects have been underway in Japan in the fields of road and railways.

Along with utilizing the tunneling technology that has been accumulated up to the present, these projects seek to develop and improve technology that will streamline construction even further. In order to respond to these needs, along with technology that has been

amassed to date, we are continuing to tackle improvement and development of new technologies.

On the other hand, there are extensive reserves of tunnel structures that have been accumulated in the past. Along with utilizing these structures safely and securely, in order to bequeath them to the next generation as sound assets, we are working to gather knowledge of members regarding technical development and innovation relating to proper maintenance and updates.

Recently, taking full advantage of the superior tunneling technology of Japan, many Japanese companies have been broken through and had success in major overseas projects.

This booklet presents a selection of some typical examples representative of the numerous tunnel projects and technological developments in Japan. I will be pleased if these articles prove useful for tunnel engineers around the world.



Nobuhiko SATO

佐藤信彦

President
Japan Tunnelling Association

Cover Photograph by
Yoshihiro Hashimoto

"A single track (一本道 Ipponmichi)",
Nanakuma Line, Fukuoka Municipal Subway

CONTENTS

01	Construction of a JES Box Culvert with a Small Separation of 40 cm from the Pier Footing of the Shinkansen Line	2
02	Large Sectional Boring as Part of the Mountain NATM Tunnel in Fukuoka City – Fukuoka City Hakata Subway Station on the Nakakuma Line (tentative name) –	3
03	Application of SENS (the extruded concrete lining system with shield) in Urban Areas with Small Overburden	4
04	Design and Construction of an Intersection Tunnel with Large Section – Hokuriku Shinkansen Line, Shin-Hokuriku Tunnel –	5
05	Summary of the Tunneling Projects along the Chuo Shinkansen Line (between Shinagawa and Nagoya)	6
06	Construction of the Tokyo Outer Ring Road	7
07	Tunnel Construction with Consideration of the Groundwater Environment – Shin-Meishin Expressway, Minoh Tunnel –	8
08	Construction of Four Large-diameter Sharply-curved Shield Tunnels – Metropolitan Expressway Yokohama Circular Northern Route, Baba Interchange –	9
09	Enlarging an Aged Tunnel while Keeping Traffic in Service – Shimoda Minami Bypass on National Highway No. 389 –	10
10	Technology of Controlling Damage in Tunnels Subjected to a Large Seismic Motion, Developed in the Shield Tunnel on the Yamatogawa Route of Hanshin Expressway	11
11	Gravity-type Precast Floor Slab Components Placed behind a Boring Machine	12
12	Enlargement of a Shield Tunnel without Interrupting Traffic – Ohashi Shield Tunnel, Central Circular Route of the Metropolitan Expressway –	13
13	Long-term Lining Concrete Curing Using New Telescopic Centre – Ganbo Daiichi Tunnel on the Shin-Tomei Expressway –	14
14	Prolonging Service Life of Sewer Pipes by the SPR Method for Various Cross Sections	15
15	Construction of a Long TBM Tunnel with High Overburden, Water Ingress and Hot Rocks – Pahang-Selangor Raw Water Transfer Tunnel, Malaysia –	16
16	Successfully Joining Tunnels at Great Depths and Under High Water Pressure Relying on Deformation Analysis – Second Tameike Sewer Trunk Line, Tokyo –	17
17	Solutions to Deal with Soil Contamination in Construction of the Narumi Utility Tunnel (Shield)	18
18	Observational Method of Shafts in the Horonobe Underground Research Center	19
19	Rapid Construction Using Long-hole Blasting in a Small-section Tunnel	20
20	New Technique to Inhibit Heaving of Road Surfaces in Tunnels without Closing Traffic – Nagano Expressway, Ipponmatsu Tunnel –	21
 Innovations in Technology		
21	New Rapid Non-core Drilling System for Long Distances	22
22	Development of a Sophisticated SB Joint for Shield Tunnels	23
23	Invert Displacement Gauge – Ground swelling measurement during tunnel construction –	24
24	New 3D Deformation Measuring System Combining a Laser Scanner and Image Processing Technology ..	24
 General Aspects of Tunneling in Japan		
List of Members		
		25
		26

Construction of a JES Box Culvert with a Small Separation of 40 cm from the Pier Footing of the Shinkansen Line

Takashi SAITO ▶ Manager, Company Structural Engineering Center, East Japan Railway Company

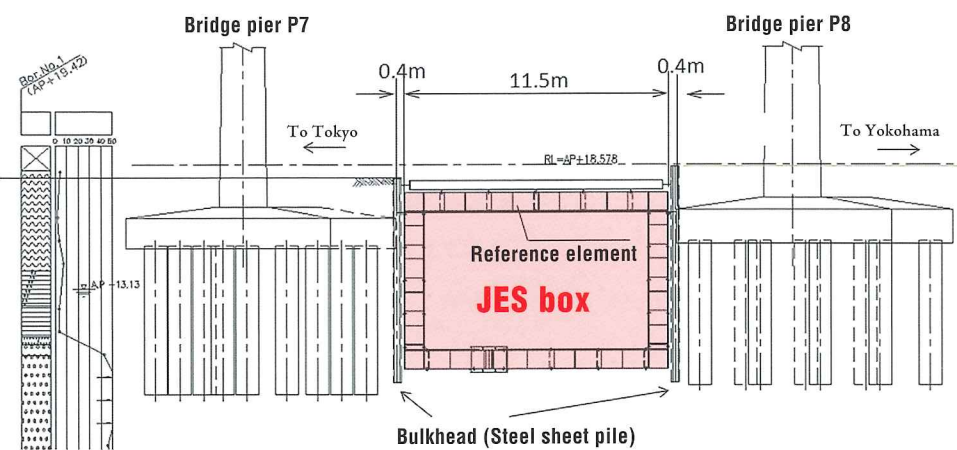

Fig. 1 Longitudinal profile

Overview

As a part of Route No. 26, an auxiliary road of the Tokyo Metropolitan City Planning Road, construction of a box culvert (11.5 m wide, 7.7 m high, 31.6 m long) was planned with one layer and a single span, located at a depth of 0.57 m underground between Shinagawa and Nishi-Oi of JR Yokosuka Line. In the vicinity of the planned route, there was a viaduct railway of the Tokaido Shinkansen running parallel with the JR Yokosuka Line. The road culvert was to be built from this elevated track, separated by only about 40 cm at the minimum, an unprecedented proximity we had not attempted in the past (Fig. 1, Photo 1).

Construction method

At this construction site for building required structures underground in the direction running across a railroad that lies above the site, we adopted a HEP & JES method (High-speed Element Pull Method and Joint Element Structure Method), which enables us to avoid the need to resort to a CUT and Cover method. The characteristic of this method is that rectangular box-shaped steel elements with small section and possessing special joints (JES joints) are placed into the ground one by one, and, by filling the interlocked joints of the elements with grout cement, are unified to form a rectangular monolithic block structure. The structure thus shaped is able to control not merely the effect of altered ground surface, but also the impact on the surrounding structures. So far, we have successfully completed 130 HEP & JES projects.

Summary of the construction

In the vicinity of the footing of the Shinkansen pier, a concrete bulkhead was built between the footing and the new box culvert. By using the bulkhead thus provided as a retaining wall, excavation was completed up to the lower height of the upper floor slab elements, while installing supports. Then the elements were introduced and installed into the ground. At the section located immediately under the railroad, elements were placed through excavation by manual labor during the night when there

was no train traffic.

In order to determine the impact of this approach on the Shinkansen piers, a line gauge system was provided along the girders of the viaduct to measure horizontal and vertical displacements. At the time of placing retaining wall elements underground, horizontal and vertical displacements were measured. This result showed that both horizontal and vertical displacements were within the predetermined warning values, 3.2 mm and 4.8 mm respectively. In the same way, for placement of the upper floor slab elements at a depth of 0.57 m immediately under the railway, we used a displacement gauge system of link type, and obtained a maximum vertical displacement of 5.4 mm (Photo 2). In the project of building the elements of a box culvert using the HEP & JES Method near the Shinkansen piers and just under the railway, we were able to complete the project successfully by keeping the impact on the railway as small as possible.

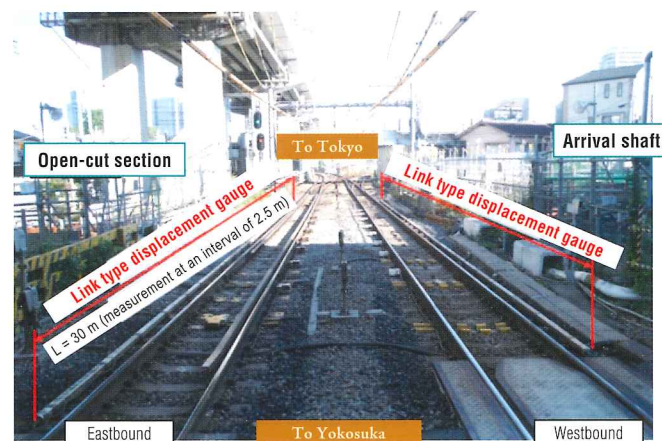

Photo 3 Track displacement measurement at the railway track crossing point



Photo 1 Construction site



Photo 2 Box culvert

Large Sectional Boring as Part of the Mountain NATM Tunnel in Fukuoka City

- Fukuoka City Hakata Subway Station on the Nakakuma Line (tentative name) -

Yasuhiro HARA ▶ Construction Department, Fukuoka City Transportation Bureau

Kenji SUZUKI ▶ Taisei, Sato, Morimoto, Sanki and Saiko Joint Venture



The Fukuoka City Bureau of Transportation is constructing an extension subway line to link Tenjin-minami and Hakata stations as part of the Fukuoka Municipal Subway.

This new line will make travelling from the southwestern area of Fukuoka City to the midtown area, as well as trips within the midtown itself more convenient, and will alleviate road congestion in the city and reduce crowding in trains on the subway airport line. The section of construction concerned is about 1.4 km long and scheduled to open in FY 2020 (Fig. 1).

In the Hakata station section (tentative name), construction is a joint venture of Taisei, Sato, Morimoto, Sanki and Saiko, and the section is divided into two segments, one is 83.7 m long using the Cut & Cover Method and the other 195.6 m using the NATM, with a total length of 279.3 m.

Geology conditions

The in-situ ground is a mudstone/sandstone alternating strata of the Paleogene period (Fig. 2). The boundary geology of soil/bed rock laying at GL-13 to -22 m has a low hardness and strength factors, with a deformation modulus with MPa of 32 to 130, and a uniaxial compressive strength of 0.1 to 0.6 MPa. Under the effect of strong weathering and alteration, the solidification is so weak that collapse of the crown and cutting face are expected if exposed to such adverse conditions during tunneling.

The overburden above the main tunnel ranges from approximately 17 to 20 m in depth (1.0 to 1.8 D, D = tunnel width). At the site of a large sectional portion forming a part of the main tunnel (excavation cross-section about 150 m²), the rock overburden is small, about 1.0 m (0.05 D) (Fig. 3).

Considerations for measurement

This plan typically includes measurement of displacements in the

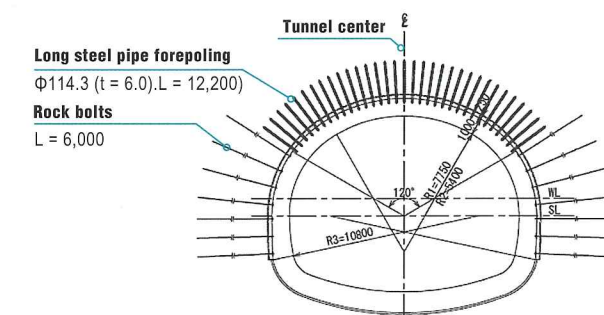

Fig. 3 Cross-section of the large cross-sectional tunnel

tunnel and of settlements on the surface (measurement A), and measurement of stress on support members (measurement B). Moreover, we planned to measure displacement of the structures existing in the vicinity, and examined appropriate auxiliary methods to prevent possible settlement and displacement ahead of the tunnel face. Consequently, in order to reduce the impact on the structures as well as the risk of the cutting face collapsing, measurements have been continuously made on the subsidence of the ground ahead of the cutting face and on the heaving of the face.

Issues and measures to be taken for tunneling

There is a highway on the ground surface above the tunnel, and in the vicinity underground, an entrance to a parking lot, a trunk sewer and gas supply ducts. From the viewpoint of maintenance, repair and safety, subsidence allowances at different parts concerned are small. Given a shallow overburden and proximity of the site to the surrounding structures, it is necessary that construction be deliberate with strict monitoring of measurements. To this end, it is essential to perform inverse analysis from measurements and feedback information in actual construction. In the future, we will continue effective auxiliary methods at the proper time with the aid of an observational construction approach so that tunneling may be performed carefully and safely.

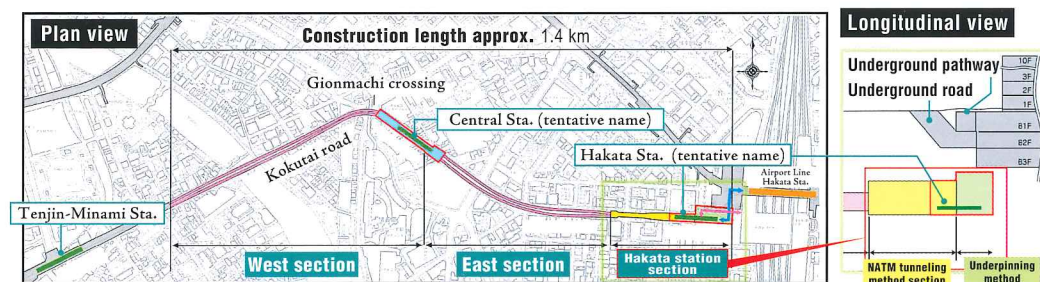

Fig. 1 Summary of the extension of the Nanakuma Line in the Fukuoka City Subway

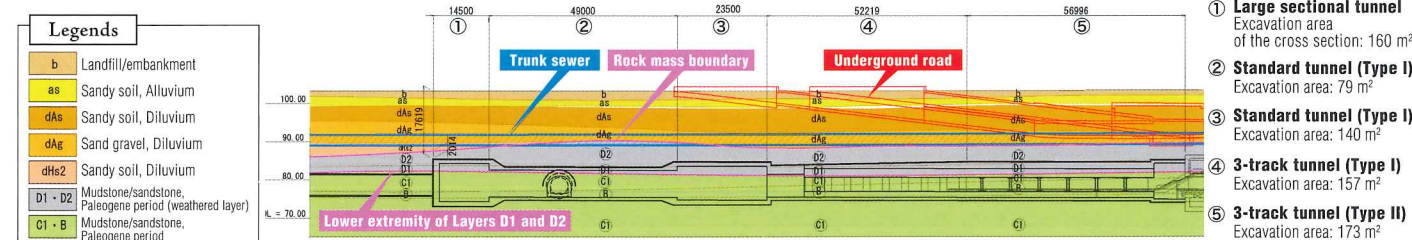

Fig. 2 Geological profile of the NATM tunneling section

Application of SENS (the extruded concrete lining system with shield) in Urban Areas with Small Overburden

Tomoaki MATSUO ▶ Shin-yokohama Construction Site Office, Tokyo Regional Bureau, Railway Construction Headquarters, Japan Railway Construction, Transport and Technology Agency (JRJT)



The Sotetsu-JR Direct Connection Line is a metropolitan railway with a total length of 2.7 km. The Nishiya Tunnel (Fig. 1) is a double-track railway tunnel with a length of 1.4 km (external diameter of 10.4 m).

Characteristics of construction of the Nishiya Tunnel

This is the third case of construction with 'Casting Support Tunneling System using TBM' (hereinafter referred to as "SENS") in Japan.

One of the characteristics of SENS is that the primary lining is made of cast-in-place concrete, so the earth pressure at the face and the concrete placement pressure could cause displacement of the ground surface. The Nishiya Tunnel crosses under an arterial road with an overburden of approximately 6.8 m. This arterial road has a heavy traffic of approximately 25,000 vehicles daily. Also, there are numerous utilities beneath the arterial road, including water and sewerage pipes, gas pipes, rainwater and sewer manholes, and telephone cables (Fig. 1). Widespread ground displacement would have an extremely large social impact, so in this case it was necessary to set appropriate limits for the earth pressure at the face and the concrete placement pressure in order to avoid affecting such facilities.

Excavation control under the arterial road

Displacement control values during the boring were determined considering opinions from administrators of the arterial road and the respective facilities beneath the road. The strictest

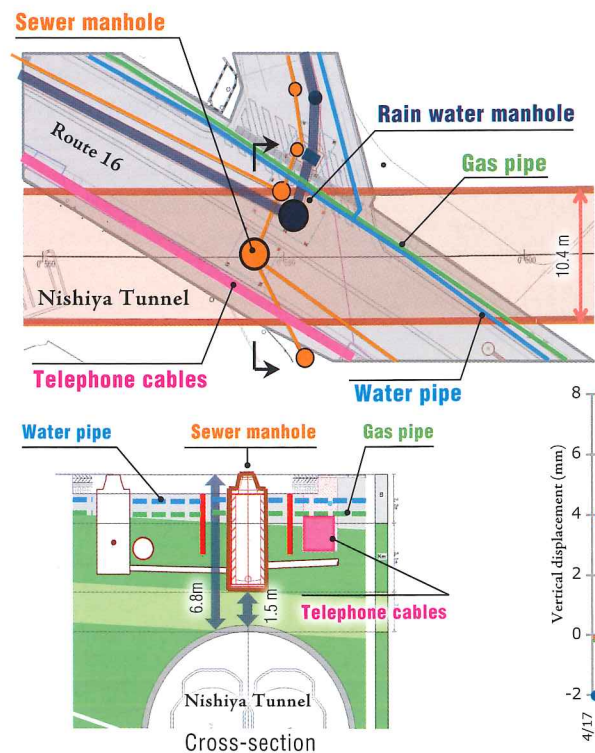

Fig. 1 Plane view and cross-section view of Route 16

displacement control values were determined with regard to gas pipes: ±8 mm. In order to enable swift response to the displacement, we established displacement control target values. The road surface was measured every two hours at points on the road surface using settlement rods installed in the gas pipes. Supplementary automatic measurements of displacement of the road surface were also taken (once every five minutes) using a total station.

The method for setting control values for the earth pressure at the face and the concrete placement pressure was determined based on the construction results in a trial zone provided within the starting yard.

Based on the primary control value for the gas pipes and the maximum control value of ±2 mm obtained through ground surface measurements in the area with small overburden in the actual excavation, the displacement control target value was set at ±4 mm and a construction flowchart was created for the crossing range under Route 16.

Construction results

Figure 2 shows the results for the two points with the largest displacement from manual measurements and the measurements made using settlement rods (Fig. 1: road surface measurement point (1) and gas pipe measurement point). A tendency for bulging was observed even before the passage of the face, and the Displacement control target value for the gas pipes (+4 mm) was surpassed during 1144R (1.2 m/R) construction, so according to the construction flowchart, adjustments were made to reduce the earth pressure at the face and the concrete placement pressure. Further adjustments in the pressure were made as work progressed, and eventually excavation below the arterial road was completed without exceeding the primary control value of ±8 mm. The results confirmed that using appropriate measurements to control earth pressure at the face and during concrete placement enables the application of SENS in diluvial formations even in urban areas.

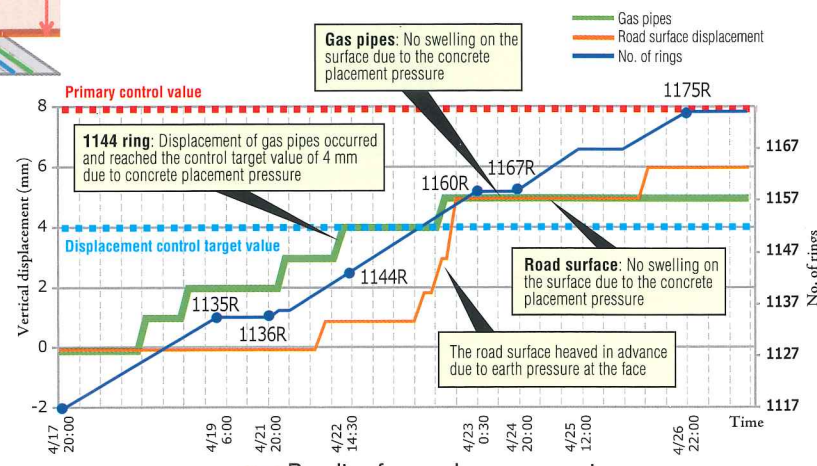

Fig. 2 Results of manual measurements of displacement for the road surface and gas pipes

Design and Construction of an Intersection Tunnel with Large Section

- Hokuriku Shinkansen Line, Shin-Hokuriku Tunnel -

Koki WAKABAYASHI ▶ Tsuruga Construction Site Office, Osaka Regional Bureau, Railway Construction Headquarters, Japan Railway Construction, Transport and Technology Agency (JRJT)



The Shin-Hokuriku Tunnel is 19.5 km, the longest in the Hokuriku Shinkansen extension. For the convenience of construction, it was divided into several sections, of which, the Okunono Segment, including a main tunnel of 4,880 m in length and an inclined shaft of 298 m, is considered to be the most challenging. The intersection point of the inclined shaft and main tunnel is designed with a large excavation cross section to install electric equipment. The cross section is approximately 130 m² while the standard section size is 80 m².

Construction at the intersection

The intersection of the inclined shaft tunnel and main tunnel is structurally weak with a concentration of stress due to the lack of supports.

When the in-situ ground condition is poor, a commonly used excavation method is to access the intersection diagonally above from the inclined shaft to the main tunnel.

However, this approach is not economical and requires longer construction time due to installation and removal of temporary supports.

On the other hand, the construction segment had an overburden of about 45 m, and the spreading of a comparatively solid and hard rock mass was predicted from a preliminary survey and excavation of the inclined shaft. For economic reasons and to shorten the construction period, we first excavated the joining part perpendicular to the main tunnel by building temporary supports to match the height of the finished crown, and then the main tunnel was expanded to the right and left removing the supports (Fig. 1). In addition, we used the bench cut method to excavate the face by dividing it into the smallest sections possible.

Numerical analysis and design

Forces of the supports were analyzed numerically for both upper extended temporary supports at the connection and auxiliary supports at support-free section.

The former includes two-dimensional finite element analyses of support strength and crown settlement of the tunnel.

The latter includes frame analyses of the auxiliary supports referring to conventional methods of the allowable stress design. In the study, it was assumed that 60% of the ground stress acts

on the supports due to excavation and sequential redistribution of the stress.

Results of construction and measurement

The ground of the intersection was a relatively hard rock mass with no water ingress and the cutting face was stable with no loosening and adverse alteration at the support members. The crown settlement at the center of the main tunnel was about 10 mm when the inclined shaft-joining portion was completed, and as boring for the main tunnel progressed, it increased to about 20 mm. Accordingly, the settlement and stress for the crown of the portion without support were slightly larger than calculated by the analysis (Table 1 and Fig. 2).

Due to some differences in the properties of the ground, the measurements on the reinforcement members at the missing part were slightly larger than calculated. It can be said that the analysis, although a simple type, was able to successfully predict the critical behavior of reinforcement supports of the portion without support with high precision. As a result, the tunnel intersection was completed successfully and safely thanks to visual inspection and management of measurements during construction.

Center of main tunnel	Analysis	Measurement
Crown settlement	13 mm	20 mm
Reinforcement of the missing section	Analysis	Measurement
Crown settlement	8.0 mm	10.5 mm
Maximum crown stress (inside of tunnel)	96 N/mm ²	125 N/mm ²
Maximum right wall stress (inside of tunnel)	101 N/mm ²	125 N/mm ²

Table 1 Comparison of measured values and analysis

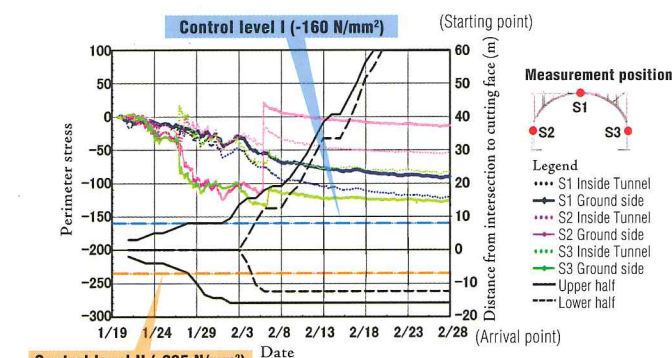

Fig. 2 Changes generating stress at the time of reinforcing the missing part

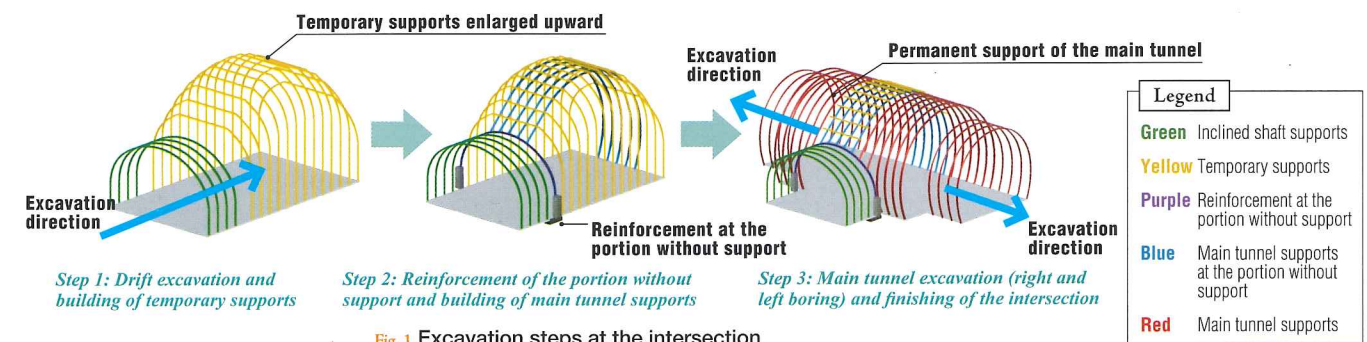
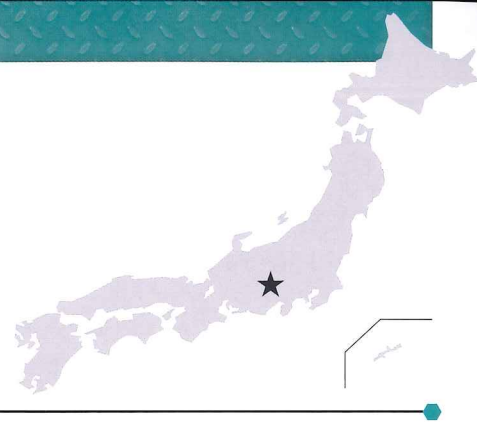

Fig. 1 Excavation steps at the intersection

Summary of the Tunneling Projects along the Chuo Shinkansen Line (between Shinagawa and Nagoya)

Toru FUTAMURA ▶ General Manager
Chuo Shinkansen Promotion Division, Central Japan Railway Company



Central Japan Railway Company (JR Central) plans to build a Superconductive Maglev Chuo Shinkansen line. The current Tokaido Shinkansen line is under operation connecting Japan's three mega cities, Tokyo, Nagoya, and Osaka. This new Maglev line, is expected to assume a central role for railway transportation in the future as an alternative to the Tokaido Shinkansen. The plan for construction of the first segment from Tokyo to Nagoya (see map) was licensed by the Ministry of Land, Infrastructure, Transport and Tourism on October 2014. 86% of the new line of 286 km is to be underground in tunnels. The Chuo Shinkansen uses a superconducting Maglev system with a maximum speed of 500 km/h and with a maximum gradeability of 40%. These unique and advantageous technologies will be integrated into the alignment plan for the Chuo Shinkansen line.

Planning of urban tunnels along the Chuo Shinkansen line

According to the plan, the underground route will traverse the metropolitan area of about 40 km from the Shinagawa Station on

Tokyo side, and that of about 20 km from the Nagoya Station. Under the Act on Special Measures concerning Public Use of Deep Underground, this railway is required to be constructed underground at as large a depth as possible because it travels through metropolitan areas. To meet these requirements, the segment around the station must pass at a steep slope to reach such depths, and for the major parts of the course from station to station, it will pass deeply underground at 40 m or more. In addition, in order to provide for efficient ventilation and smooth evacuation in emergencies, emergency exits of around 30 m in diameter, which can be used for both ventilation and evacuation, will be constructed at intervals of about five kilometers; the starting and arrival shafts also will be converted to this function, after their use ends.

Planning for mountain tunneling

Some mountain tunnels on the course of the Chuo Shinkansen line (between Shinagawa and Nagoya) are also to be constructed on the maglev line: two of these tunnels will be extremely long, one on the route of Yamanashi, Shizuoka and Nagano (Minami Alps Tunnel) and the other on the Nagano-Gifu route (Chuo Alps Tunnel), each exceeding 20 km. Since the Minami Alps tunnel passes under the most prominent mountain range in Japan, this alignment needs to be bored at the steepest upward slope and with a maximum overburden of about 1400 m.

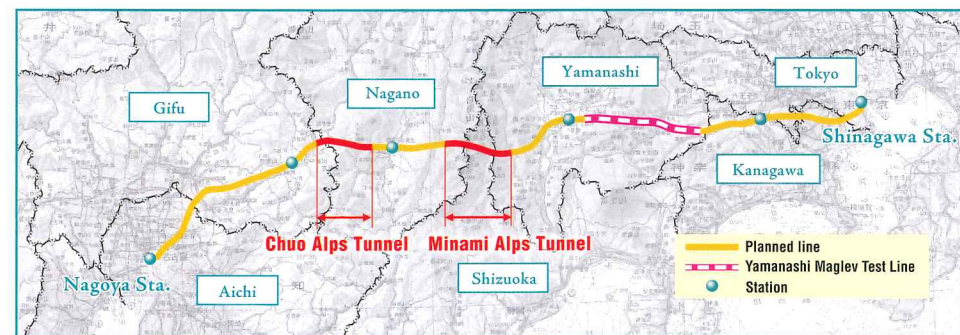

Fig.1 Planned route between Tokyo and Nagoya

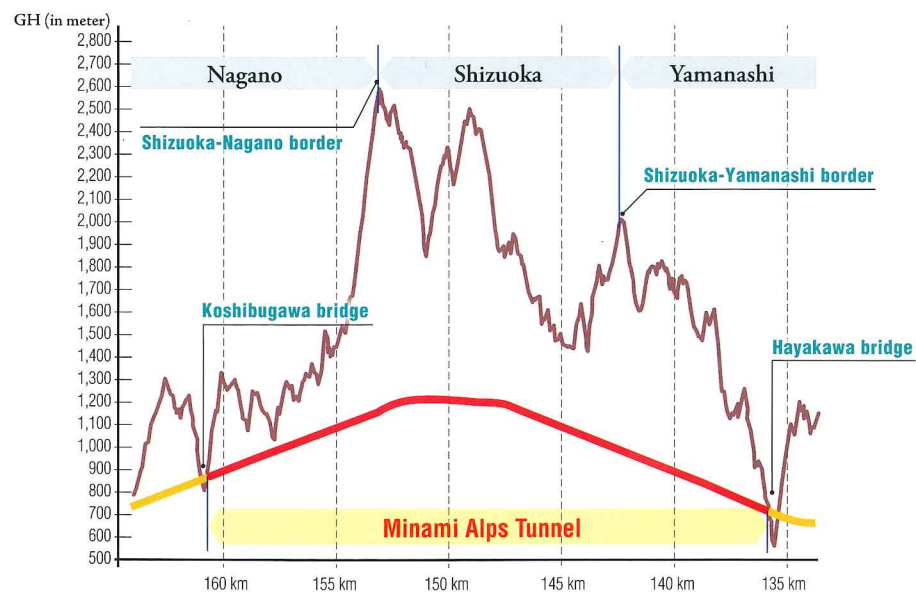

Fig.2 Longitudinal profile of the Minami Alps Tunnel

Considering the above condition, we are now developing a boring machine with much better performance than ever. This system is expected to provide the capability of boring the tunnel at high speed, with a large diameter and highly precise control, by understanding the geology ahead of the cutting face. For the construction of the Chuo Shinkansen line, we will adopt state-of-art technologies for measurement, evaluation and construction methods, and focus our efforts on work safety, environmental preservation, and cooperation with local communities.

Construction of the Tokyo Outer Ring Road

Takashi SHIDOJI ▶ General Manager (Engineer), Tokyo Outer Ring Road Investigation Office, Kanto Regional Development Bureau, Ministry of Land, Infrastructure, Transport and Tourism

Keiichi HORI ▶ General Manager, Tokyo-Gaikan Construction Office, Kanto Regional Head Office, East Nippon Expressway Company Limited

Satoshi GODA ▶ Director, Tokyo Construction Office, Tokyo Branch, Central Nippon Expressway Company Limited



Summary of the project and current status

Summary of the construction project (Kan-etsu to Tomei)

The Tokyo Outer Ring Road, one of the three ring roads in the metropolitan area, was an arterial high-standard highway about 85 km long, for traffic in a radius of about 15 km from the metropolitan center (Fig. 1).

The segment between Kan-etsu Expressway and Tomei Expressway (approximately 16.2 km of the total length) was decided to be built in 1966 as an elevated highway as part of the urban plan. This plan, however, was met by a fierce opposition due to concerns of possible environmental impact, and virtually frozen at the time. Subsequently in 1999, the governor of Tokyo announced that this section should be constructed underground, and the Ministry of Land, Infrastructure, Transport and Tourism (MLIT) and Tokyo Metropolitan Government in 2001 published a draft for the section to be an underground structure. In the following years, study had continued to incorporate various opinions from local communities into the plan, and in 2007, a decision was made in the city plan to change the original route to an underground route "at great depths," 40 m or more. The

tunnel covering this segment will be three lanes on each side and approximately 16 m in diameter, and when finished, will be the largest shield road tunnel in Japan (Fig. 2).

Challenging issues and countermeasures

1 Shield tunneling of the main road

We considered that it would be difficult for this shield tunnel to meet the requirements of "large cross-section, long distance and high speed construction," and it was expected that the longer the distance of tunnel boring, the larger the risk that problems would occur. Therefore, in case of unforeseen trouble during tunneling, we provided a solution making it possible to continue tunnel boring flexibly by prolonging boring distance for either of two sides for each tunnel (north bound and south bound). To this end, we adopted the start of tunnel boring from two portal sides, and manufactured 4 shield machines. One pair of machines were placed and started from one side, and the other pair from the opposite side. The two tunnels from one side proceeded along the predetermined course in a way that they joined underground, with the other two coming from the opposite side.

Prior to the tunneling project, in order to bore a long distance tunnel quickly and steadily, we examined construction management technologies, including monitoring, as well as auxiliary techniques. Since the tunnel starting from Oizumi was known to interfere with the reinforced concrete foundation piles of the existing elevated bridge, we verified a technology of coping with the problems relating to the in-situ piles interfering with the shield tunnel.

2 Underground portion needing a width enlargement

At places merging with ramp tunnels to the Tomei junction, Chuo junction and Omekaido interchange, it is necessary for the main tunnel to be enlarged underground without using the Cut & Cover Method (hereinafter called "underground enlarged portion"). To meet the requirements above, the committee set up a feasibility study to study a "basically circular geometry" which is able to have a "sufficiently wide zone of water tightness." Prior to the project, we publically solicited solutions for an underground enlargement method, and are currently verifying the techniques proposed.

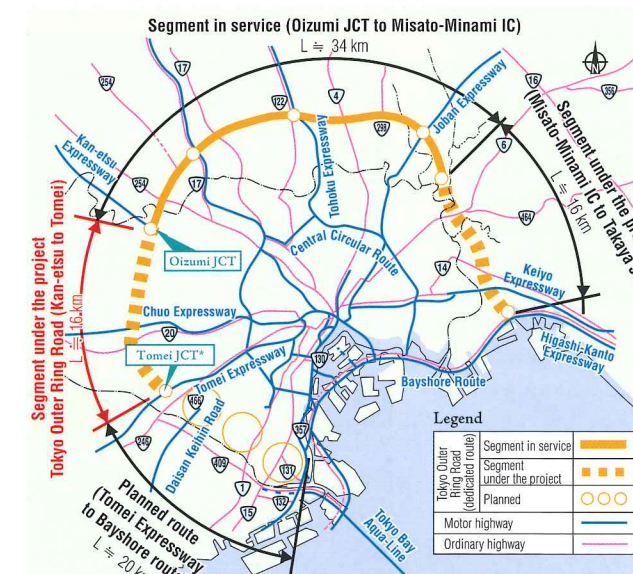

Fig.1 Overall plan and the arterial highway map (as of the end of December, 2015)

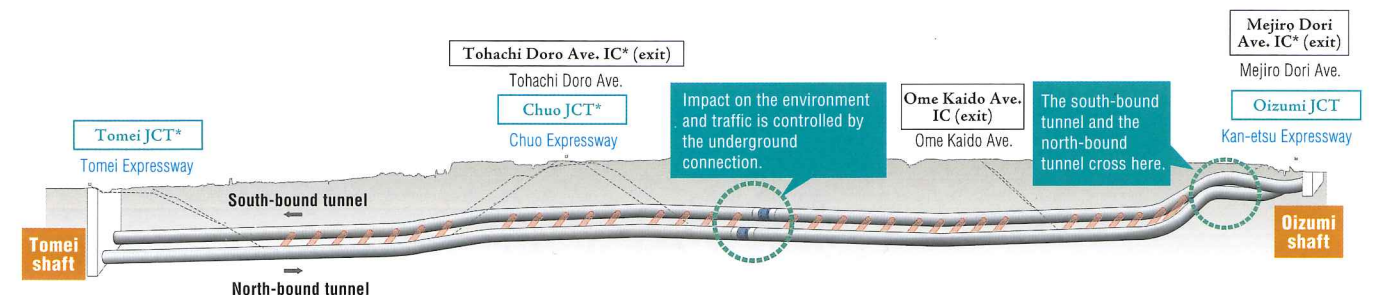

Fig.2 Main shield tunnel

(*) Tentative name

Tunnel Construction with Consideration of the Groundwater Environment

- Shin-Meishin Expressway, Minoh Tunnel -

Kenichiro NANBA ▶ Chief
Shinmeishin Osaka Nishi Construction Office, Kansai Regional Branch,
West Nippon Expressway Company Limited



The Shin-Meishin Expressway links mega cities in the west in Japan, Nagoya with Kobe via Osaka. The Minoh Tunnel is located on the expressway in the northern part of Osaka Prefecture. The total length is approximately 5 km with two lanes each on the inbound and outbound lanes. The tunnel crosses the Katsuoji River at a point located approximately 1 km from its eastern entrance with an overburden of approximately 20 m. The area of the Katsuoji River is located in the vicinity of Minoh Quasi-National Park, an area with an abundant natural and water environment that is also actively used as a source of water for agricultural purposes by local residents.

Basic measures to preserve the water environment

It was concerned that tunnel excavation might have a negative impact on the water environment in the vicinity of the Katsuoji River. The following measures were taken in order to alleviate such concerns.

- (i) Adoption of lining for a waterproof structure (WT): WT was adopted for the area directly below the Katsuoji River and the surrounding area with a high concentration of fault fracture zones. The effect of this measure was confirmed through a three-dimensional seepage analysis that used actual ground parameters from before and during construction.
- (ii) Diversion of Katsuoji River : river water was diverted in the section where the tunnel crosses the river using artificial waterways and water pipes.
- (iii) Return of tunnel water inflow: in preparation for possible impact on water utilization, a small-section tunnel and vertical shaft were built that could return tunnel water inflow even during construction.
- (iv) Monitoring groundwater during construction: in order to collect information on the hydrological characteristics of the area ahead of the tunnel face, ultra-long boring (Photo 1), long boring, and drilling surveys were conducted separately for all routes. At the same time, the hydrological state was monitored in order to grasp the impact on the water environment in real time, thus enabling precise countermeasures to be proposed swiftly in the event of possible impact, enabling rational construction.



Photo 1 1,000 m-class ultra-long pilot boring

Method to recover groundwater after WT (watertight) construction

Some of the factors that complicate groundwater recovery are leakage from the lining and flow of groundwater in the longitudinal direction of the tunnel.

- (i) Measures to deal with leakage from the lining (It is essential to build leak-free WT, and, in the event that leakage occurs, to cut it off in a precise and appropriate manner.)
 - In order to prevent breakage of waterproof sheets, the rock bolt heads were entirely covered with shotcrete. Next, the shotcrete surface was scraped and smoothed (Photo 2).
 - The waterproof sheets in the box-out sections for emergency facilities are normally welded manually, so the tunnel face was widened in order to enable automatic welding.
 - Reinforcing bars are placed in the entire circumference of the tunnel, so middle-performance concrete with high self-filling properties was used to attain a dense concrete structure.
 - In preparation for possible leakage from the lining, a water barrier system and a repair system that can be used to easily cut off water were adopted. These systems utilize urethane with long-term durability as grout to cut off water only in areas where leakage has occurred.
- (ii) Prevention of flow of groundwater in the longitudinal direction of the tunnel
 - The WT edge is located in ground with low water permeability (permeability coefficient below 2.7×10^{-7} (m/sec) for 1D (approximately 12 m)). Fan curtain grouting using ultrafine particle cement was applied in preparation for possible loosening of ground due to excavation.
 - In order to prevent occurrence of gaps and voids that are likely to appear in the crown of the lining, contact grouting was applied using low shrinkage cement.
 - After the installation of waterproof sheets on the entire circumference of the tunnel, temporary drain pipes were installed to prevent pressure on the sheets caused by recovery of the water level. After placement of concrete, shrinkage-compensating grout was applied as blocking measure.

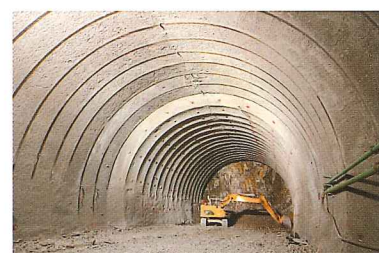

Photo 2 Smoothing of shotcrete surface (up front: WT section, in the back: non-WT section)



Photo 3 Lining in the WT section

As a result of the various measures summarized above, the project had no significant impact on the groundwater environment.

Construction of Four Large-diameter Sharply-curved Shield Tunnels

- Metropolitan Expressway Yokohama Circular Northern Route, Baba Interchange -

Naofumi SOEJIMA ▶ Deputy Manager
Design Division, Kanagawa Construction Bureau, Metropolitan Expressway Co., Ltd



The Yokohama Circular Northern Route is the northern section of the Ring Expressway, which forms the backbone of the transportation network of Yokohama City. It is a limited expressway with a total length of 8.2 km (tunnel section length is 5.9 km), which connects the Daisan Keihin Line and the Yokohama-Haneda Airport Line. The Baba Interchange will be built approximately halfway along the route of the expressway. The ramps will be built as four tunnels, using the shield tunnel construction method.

Characteristics of construction

Each of the tunnels for the four ramps will be built with the minimum required diameter, taking into account the road alignment as well as the inner space conditions dictated by clearance limits and ventilation facilities. For this reason, the tunnels for each ramp will be built with different diameters, and the external diameter of the shield will range from $\phi 10.1$ m to $\phi 11.1$ m (Fig. 1).

The four ramps will have a steep longitudinal slope of 7%, and in both Ramp B and Ramp C there will be sharply curved sections with a minimum curve radius of 50 m. Moreover, excavation for Ramp B will start at a location with small overburden of 1.3 m. Overall, the project requires an advanced construction management (Photo 1).



Photo 1 Ramp B starting area

An examination of the geological characteristics with Ramp B as the case study shows that the approximately 450 m-long zone of excavation is composed of diluvial clayey soil and sandy soil, alluvial clayey soil

containing humus, Kazusa layer mudstone, as well as sand and sandstone, so excavation involved significant variance in geological components (Fig. 2).

Furthermore, in this construction project, the shield machines in three of the tunnels (Ramp A, Ramp C, and Ramp D) start from one starting shaft, so in the construction of two of the three tunnels it will be necessary to take into account the impact of subsequent tunneling for adjacent construction. Also, the shield machine of Ramp C will cross an area at a depth of approximately 5 m directly beneath the starting portal of the tunnel for Ramp B. These factors indicate that the project will have crowded spatial restraints, so the design takes into consideration the mutual effects among adjacent tunnels.

The arrival section of the ramp tunnels is where they connect with the main line tunnel. The four ramp tunnels will connect underground with the main shield tunnel, which is built using the same shield method (Fig. 3).

Status of construction

In February 2016, of the four ramp tunnels, excavation of the Ramp B shield tunnel was able to be completed, overcoming various issues, such as the small overburden, sharp curves, and steep slope. The remaining three ramp tunnels will be constructed taking advantage of the knowledge and experience gained through the construction of Ramp B.

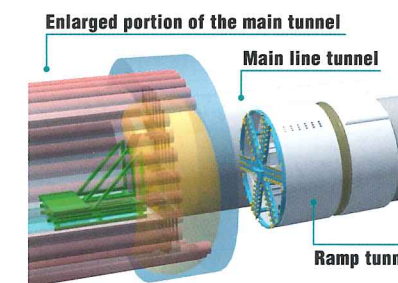

Fig. 3 Image of the underground connection section

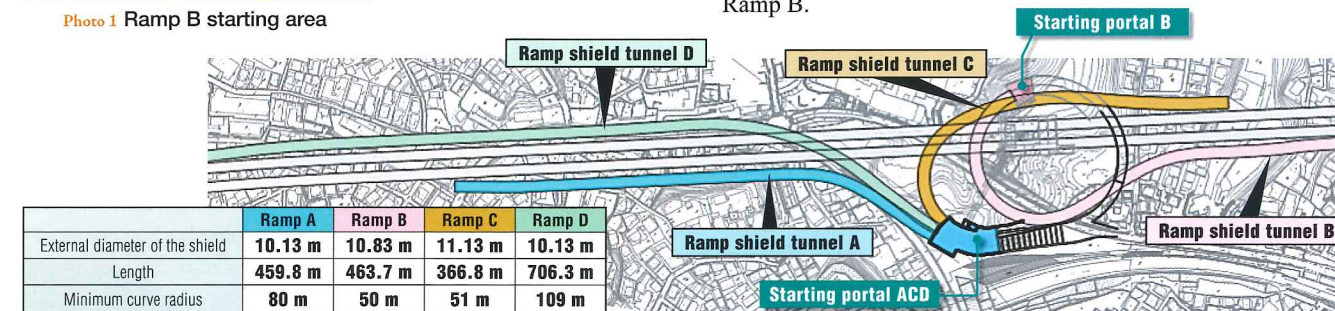

Fig. 1 Overall ground plan of the Baba Interchange

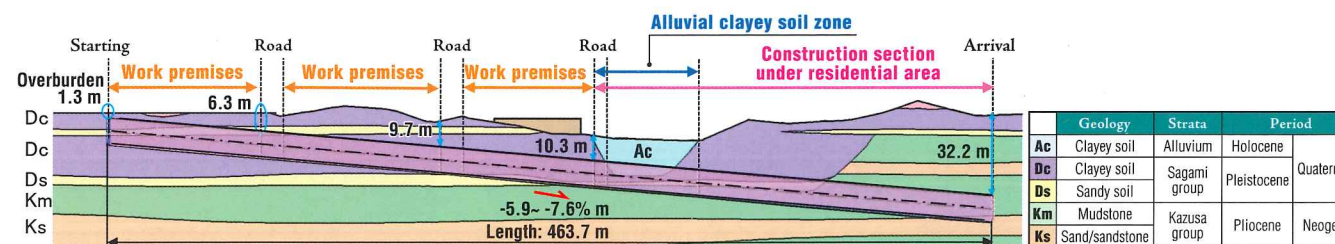

Fig. 2 Longitudinal profile of the geological conditions for Ramp B

Enlarging an Aged Tunnel while Keeping Traffic in Service

- Shimoda Minami Bypass on National Highway No. 389 -

Shizuo MIYABE ▶ Director
Road Construction Division, Road and City Administration Bureau,
Department of Civil Engineering, Kumamoto Prefectural Government

The Shimoda Zuido, - 'zuido' means tunnel in Japanese -, on National Highway No. 389 is a road tunnel with 49 m long, in southwestern Kyushu island. The tunnel, after about 75 years of service since its completion in 1936, was exceedingly deteriorated. Moreover, the tunnel was very small in width to an extent that two vehicles could not pass each other, and in a need to be enlarged.

As a work condition, the traffic of this road could not be totally closed, because there was no detour in the neighborhood. Therefore, the tunnel was refurbished by in-service enlargement method, which widened the tunnel's cross section, while keeping traffic service for ordinary vehicles. The work was started in March 2012.

Excavation methods and safety measures

In the surrounding topography, a mountain area of an altitude of 400 m or less protrudes into the sea, and the road runs along the coast at the foot of the mountain.

Blasting excavation was used, considering that the ground in-situ was composed of good hard rock belonging to the sedimentary rock of sandstone, conglomerate and rhyolite of Late Cretaceous period. For the blasting section, a gate-shaped steel frame, called 'protector system,' was placed to provide safety to traffic vehicles.

On the perimeters of the tunnel at both portals, some places on the mortar-lined slopes were observed to be aged and deteriorated. There was a concern for that section that pieces of rock mass might fall off and the mortar spall, due to blasting vibrations. Therefore, safety measures to protect the slopes were taken in advance with wire ropes and anchoring systems. Moreover, in order to monitor slope behavior due to vibrations of blasting and earthquakes, a warning system was introduced for safety management which is designed to issue a warning when the earth produces a certain level of displacement.

Construction method

The construction method for this tunnel was as follows. In the first step, a protector system was installed inside the existing tunnel,

and air mortar was injected and filled into the perimeter space between the walls of protector and existing tunnel. Under this condition, the ground in-situ on the coastal side was excavated by blasting. Following the completion of excavation on the coastal side, general traffic was shifted to the lane on the coastal side.

The next step was removal of the protector system by excavating the mountain side with a large oil-pressure type demolition equipment. After completion, the inverted arch structure was installed there. Then traffic was shifted again to the mountain side to install also the coastal inverted arch concrete.

Finally, the walls of the tunnel were lined with cast-in-place concrete where general traffic was safeguarded under the tunnel lining form.

It was necessary to exert careful attention to the blasting process. With almost no adverse effect on the surroundings, the project was able to be finished within about one month, thanks to previous protective measures to minimize the impact of noise and vibration.

The project imposed a severe site condition for enlarging the tunnel's cross section while allowing general traffic. It was the first attempt for the road administrator in this region to attempt work maximizing use of existing infrastructural stock. The project was able to be completed successfully in January 2014, approximately 2 years from the start.

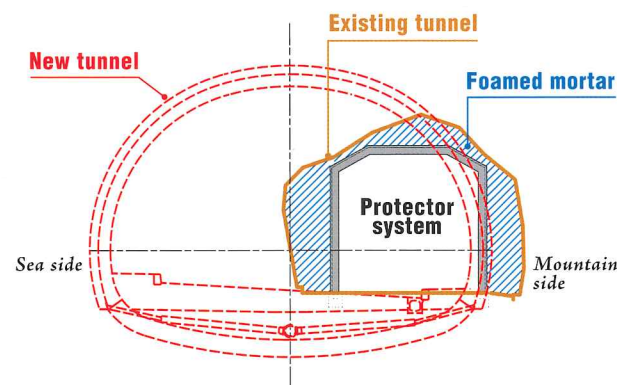

Fig. 1 Schematic of cross-section for excavation



Photo 1 Shimoda Zuido before the construction



Photo 2 Inside the protector system



Photo 3 Safety measure on the slopes at the portal perimeter

Technology of Controlling Damage in Tunnels Subjected to a Large Seismic Motion, Developed in the Shield Tunnel on the Yamatogawa Route of Hanshin Expressway

Tsutomu NIINA ▶ Assistant Manager, Sakai Construction Department,
Construction and Renewal Management Headquarters, Hanshin Expressway Company Limited

Koichi TAMADA ▶ Group Leader, Shield Group, Underground Space Design Department,
Civil Engineering Headquarters, Kajima Corporation

Introduction

In the southern district of Osaka, Yamatogawa Route of Hanshin Expressway is currently being developed by three parties, Osaka Prefecture and Sakai City Governments and the Hanshin Expressway Company, as a part forming the ring road for Osaka Urban Redevelopment (See Fig. 1).

The Yamatogawa Route is about 9.7 km long, and for most of the route underground structures have been built using tunneling by the Shield Method or by the Cut and Cover Method. This report summarizes techniques for controlling damage which were adopted in the shield tunneling in the western section.

Summary of a new seismic design

The new seismic techniques for this project were used for parallel shield tunnels of 12.230 m in external diameter and 2.0 km in length. These twin shield tunnels were extremely close to each other, separated by only about one meter (0.08 D in external diameter of the tunnel) (Fig. 2).

The seismic design for the Yamatogawa route provides three levels of seismic motion; level 1 is a seismic motion of a high probability which is expected to occur in the service life. Level 2 is a seismic motion of high intensity. The largest level is the one represented by a postulated scenario reflecting the most intense destruction with a force which may possibly act in the Uemachi fault crossing the Yamatogawa route, potentially having significant impact on the design section. Considering the maximum level of seismic motion and an extremely low probability in the service life, the required seismic performance level was evaluated.

By assuming that the maximum level of seismic motion occurs in the axial direction, the model thus created assumed that compression force is predominant in the axial direction of the tunnel. To cope with this issue, we developed and used a steel segment which by itself was deformable for damage control in the tunnel where compression force prevails, while controlling deforming forces to within the limit required.

Steel segment for damage control

The vertical rib of the segment is designed to have a resistance larger than the axial force under seismic motion larger than Level 2, and to yield or buckle under the largest seismic motion scenario. With reference to compression deformation due to buckling, the stress working in the axial direction of the tunnel was able to be controlled within the minimum allowance. Additionally, axial force-transferring components were installed with appropriate strength to prevent unnecessary deformation of the segment. The structure of the segment (concept of a compression deformation) is shown in Figure 3.

Figure 4 shows the view of the tunnel under construction. We confirmed that the segment that can control damage developed for this tunneling project is able to provide seismic protection with excellent durability, maintenance and economy while achieving required safety against seismic motions at each level.

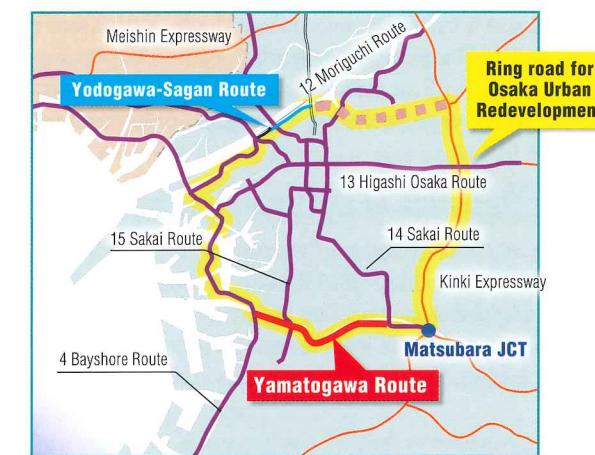

Fig. 1 Location of the Yamatogawa Route

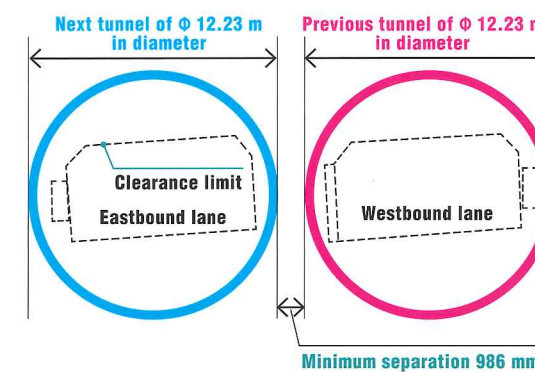

Fig. 2 Cross-section

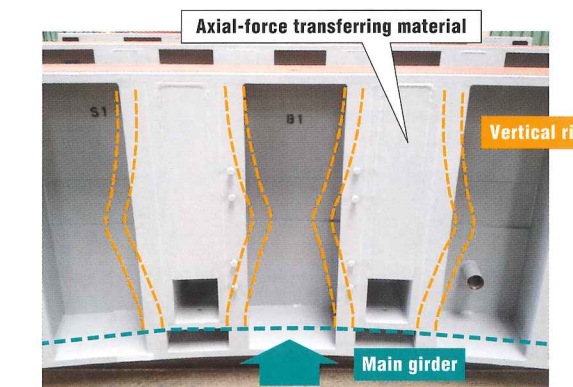

Fig. 3 Structure of the segment (compression-deformation model)

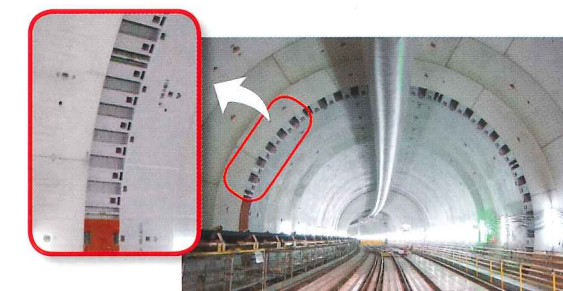

Fig. 4 View of the construction

Gravity-type Precast Floor Slab Components Placed behind a Boring Machine



Masahiro KIKUCHI ▶ Head of Engineering Work Section, Kawasaki National Highway Office, Kanto Regional Development Bureau, MLIT

The Tokyo Port Tunnel is on a national highway that runs parallel with the Bay Shore route of the Metropolitan Expressway. EPB type machine with an outer diameter of 12.2 m was used to bore a 1470-meter route, including a construction segment under the seafloor.

Characteristics of the tunneling project

1) Starting and arrival on the ground surface

Generally, in tunneling with TBM, two shafts are provided: one at the starting portal and the other at the arrival portal with a certain overburden. However, this tunnel was bored from and to the ground surface, towing all the carriages at each portal area.

2) "Box dump method"

Given the conditions of the project, the tunneling route was planned with a shallow overburden. Therefore, the tunnel was required to resist upward force of buoyancy by utilizing the weight of machine itself. Immediately after advance of the machine, precast concrete components were placed as an additional weight against buoyancy to keep the tunnel stable.

Unlike the conventional placement of cast-in slab concrete, this method made it possible to tunnel faster than usual thanks to the weighted roadbed slabs transported by dump trucks behind the excavating face.

3) Proximity construction

The distance to the existing Bay Shore route was about 17 m. Therefore a measuring instrument was installed in the immersed tube of the route to automatically monitor the impact from the shield tunneling.

Technological achievement

During the assigned construction period of about 10 months, there was no significant trouble requiring excavation to be stopped, with a maximum excavation rate of 338 m per month. The maximum vertical displacement was 4 mm, which was negligible, producing no impact from the buoyancy of segments. We were able to complete the tunnel safely through careful excavation, and to manage the tunneling without producing any impact or special displacement to the adjacent immersed tube.

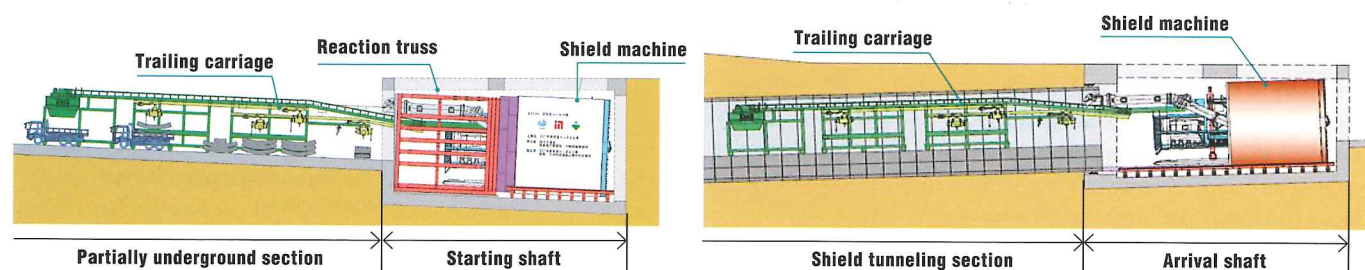

Fig. 1 Diagram of shield boring starting and ending on the ground surface

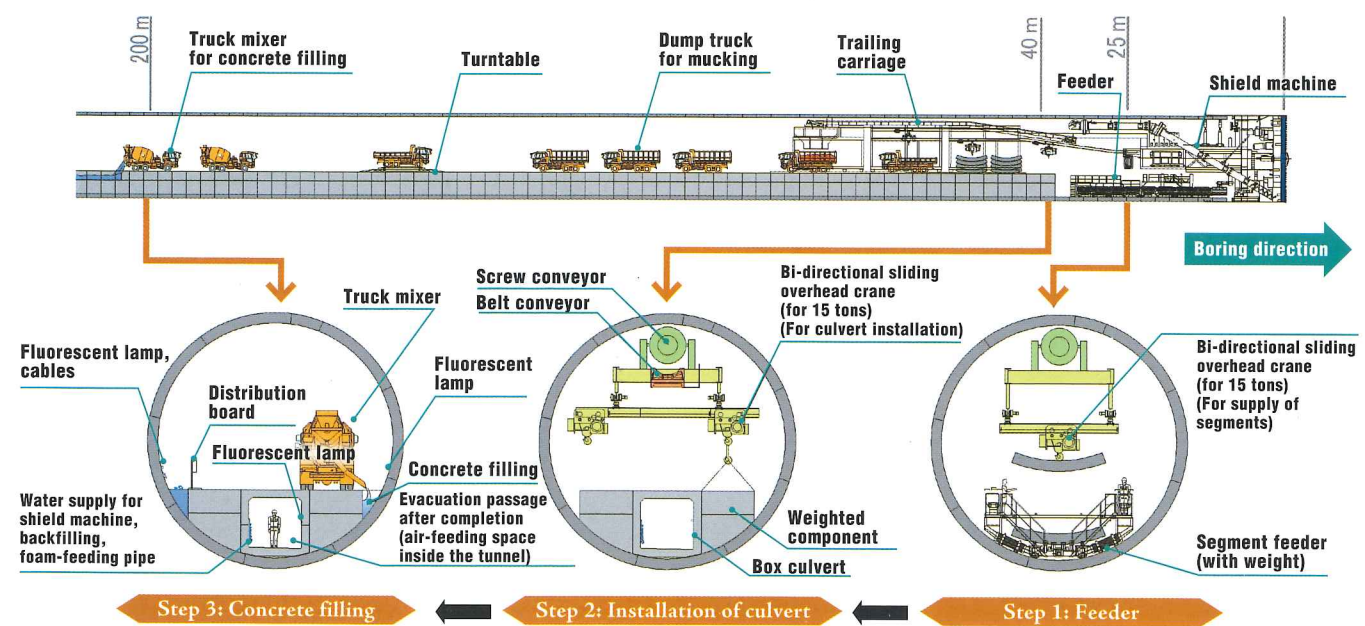

Fig. 2 Construction phase of the Box dump method

Enlargement of a Shield Tunnel without Interrupting Traffic

- Ohashi Shield Tunnel, Central Circular Route of the Metropolitan Expressway -



Daisuke MIYAMA ▶ Deputy Manager, Engineering Division, Metropolitan Expressway Company Limited

The Tokyo Metropolitan Expressway Central Circular Route, forming the innermost ring of three circular routes, is 38 km long. The last segment that is 9.4 km long (on the Shinagawa Line) was opened in March 2015. As a result, the tunnel section of 18.2 km has become the longest road tunnel in Japan. The tunneling work involved was a sophisticated structure without precedent, which consisted of enlarging the tunnel cross-section of the Ohashi Shield Tunnel where the branching-off and merging to and from the Shinagawa Line were to be provided at two points on the Central Circular Route (Fig. 1).

Shield tunneling of the Ohashi Tunnel

This project was to construct two tunnels of about 430 m which are laid in a vertical configuration, with a segment ring of 12.65 m in diameter.

In the configuration of two tunnels, the maximum overburden was 43.8 m, the minimum separation between them 1.5 m, and the minimum curve radius 123 m. By using the shaft as a place where the shield machine moves and makes a U-turn, it was possible for a single shield machine to excavate two tunnels.

The segment ring on the enlargement side was designed as an extended structure to make the RC frame and segments monolithic, by placing a skin plate on the inner side which was constructed on the reinforcing bars that had been laid previously (Fig. 2).

With these arrangements, it was possible to enlarge the cross-section to a desired size, without restricting the service of the traffic lanes in operation.

Cutting and enlargement of the Ohashi Shield Tunnel

There were two types of places needing cutting and enlargement;

the one was on the upper tunnel, extending 40 m (Fig. 1, Section A-A), and the other 250 m long on the both upper and lower tunnels (Fig. 1, Section B-B).

The tunnel's frame was formed through cutting and enlargement using the following steps. First, the site was excavated by a cut and cover method (partially, by NATM), and the desired frame was completed by an inverted lining method. After the cross-section of the tunnel was enlarged, the segment ring, forming part of the section enlarged, was removed by gas cutting. During this process, a protection panel was provided between the in-service traffic lane and the working space, since there was concern that the smoke and cutting debris might be discharged from the working site to the road lanes.

The upper section of enlargement was of an opening and closing type for fear that the work there might exert an adverse effect on the ventilation of the road tunnel in service.

To confirm the safety during cutting and enlargement, all the steps of cutting start, construction of frame structure, cutting and enlargement, backfilling and stiffness reduction were managed by using a 2D FEM sequential analysis to predict the behavior. At each step of construction, a reference measurement value was provided to manage construction. With all these means, we were able to complete the project safely.

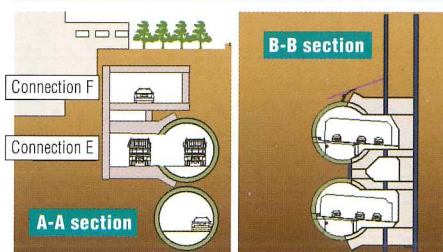
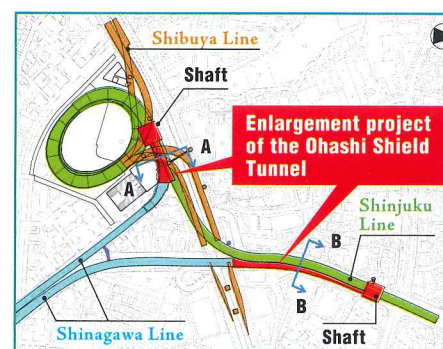

Fig. 1 Location of the project

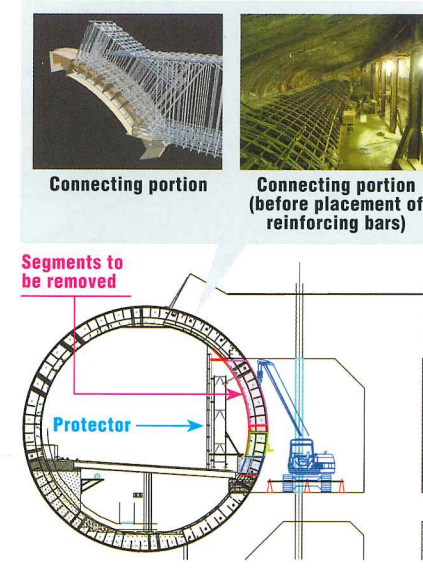

Fig. 2 Segments of the enlarged section



Photo 1 Placement of the protector (road side)



Photo 2 Segment cutting (work side)

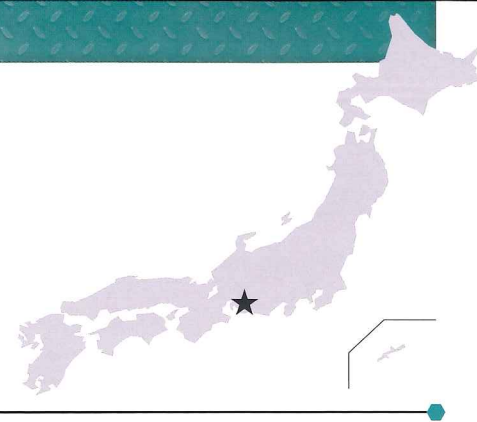

Photo 3 Completion

Long-term Lining Concrete Curing Using New Telescopic Centre

- Ganbo Daiichi Tunnel on the Shin-Tomei Expressway -

Satoshi HASHIZUME ▶ Toyokawa Construction Office, Central Nippon Expressway Co., Ltd.



Introduction

An urgent issue for us today in the area of construction and maintenance of a reliable social infrastructure is prolongation of service life of civil engineering structures. For tunnels, various new technologies have been developed to prolong the service life of lining concrete. This article discusses a new method named Telescopic Centre (hereinafter "special formwork") with a special view to accelerating the initial curing of lining concrete.

Overview of the special formwork

The special formwork system (twin arch form) used for this project is composed of two formworks (arch forms) and a gantry platform. One form is put in place for concrete placement and curing, while the other is moved to the next segment for the same operation. Thus, concrete placement and curing can alternate, shifting places every two days, and is proven effective for placement of lining because sufficient time (period of curing of concrete in the form) can be obtained by maintaining the form in place (Fig. 1).

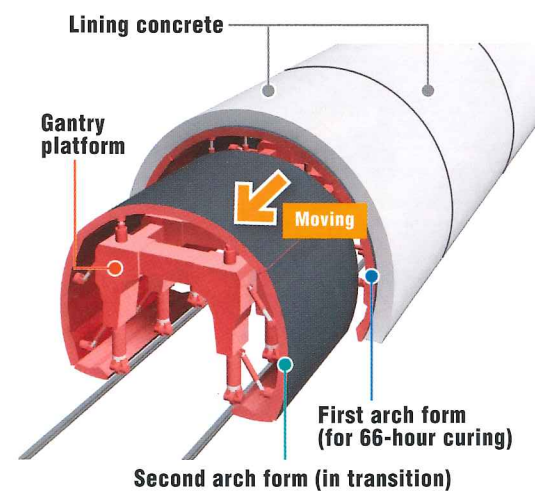

Fig. 1 Schematic diagram of the special formwork

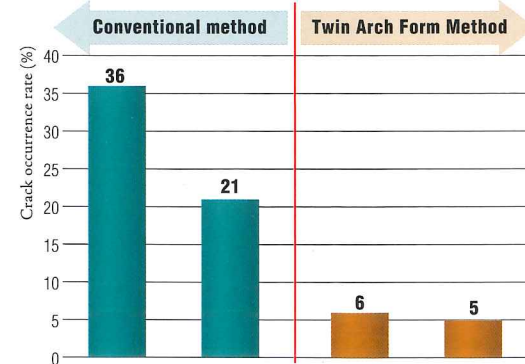

Fig. 2 Comparison chart of initial crack rates

Effects of initial curing with the special formwork

The following three benefits of the initial curing were verified.

- 1) Added supporting force to resist the dead load of the arch: To reduce the tensile strain working along the inside periphery of the crown at the time of removing the form.
- 2) Heat insulation effect: To mitigate the thermal strain that may develop due to temperature difference from inside the concrete when the lining surface is cooled rapidly.
- 3) Moisturizing effect: To reduce contraction strain, which may be produced when the lining surface is dried initially.

With these advantages, the initial cracking rate is approximately one-fifth compared to the conventional method, as shown in Figure 2. As shown in Figure 3, the permeability coefficient of the lining surface given by the Torrent Method is about one-tenth compared with that of the conventional lining method. Thus, it is validated that the use of special formwork contributes to quality improvement of the concrete lining surface and reduction of initial cracking rates. Consequently, the twin arch form system is considered an effective means to prolong the life of lining concrete considering the following points: control of concrete degradation resulting from water penetration (condensed water) and control of crack development in the future.

Conclusion

By increasing the number of arch frameworks in simultaneous use up to three or four, this system will enable longer curing time for good concrete quality (allocation of a longer time for maintaining the formwork in place) as well as placing concrete at a higher rate (shortening of construction periods). It is extremely flexible and able to be adapted to the needs of various sites.

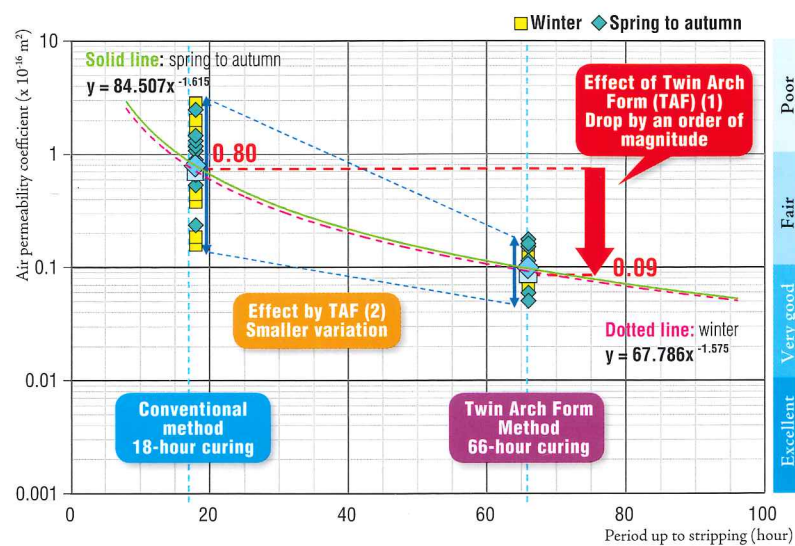

Fig. 3 Measurement of air permeability coefficient

Prolonging Service Life of Sewer Pipes by the SPR Method for Various Cross Sections

Satoshi INATA ▶ Deputy Director, Design Coordination Section, Construction Division, Bureau of Sewerage, Tokyo Metropolitan Government



Background

In the 23 wards of Tokyo, construction of the sewerage system started about 130 years ago, and currently has a total length of about 16,000 km.

As a result of its long history, degradation and aging have been progressing, primarily in the sewerage facilities built in the early years, with 1,800 km of pipelines exceeding the legal service life of 50 years. Furthermore, the length exceeding the service life is expected to increase by about 8,900 km in the next 20 years.

We have to address the urgent task for aged pipelines (sewer reconstruction project), however, the project is not easy in urban areas. First of all, since the sewer runs mostly under roads where various structures are embedded, the work, if performed with the Cut & Cover Method, will exert a significant impact on traffic and residents' lives along the roads. Moreover, there is economic activity 24 hours a day, so halting sewerage service for a long time for construction is impossible. Especially, restoration and reconstruction of large-diameter sewer pipes called trunk sewers by the Cut & Cover Method would be extremely difficult, because the project would be enormous.

To cope with these problems, the Bureau of Sewerage of the Tokyo Metropolitan Government developed a Spiral Wound Trenchless Pipeline Renewal (SPR) method in cooperation with a private company starting in the mid 80's when sewerage coverage had reached almost 100%. This new method does not use the Cut & Cover Method and enables work to continue without stopping sewerage service. Initially the method was intended for sewer pipes with small diameters, and consequently we were able to develop a more flexible method in the late 90's applicable to sewer pipes of non-circular section with large diameters, that is, a SPR method able to cope with different cross sections.

Technology overview

The sewer pipe renewal method can be used for all cross-sectional shapes, rectangular, horseshoe and oval.

The construction steps are as follows. First, from the PVC (profile) reel provided on the ground surface, the profile material is fed into the existing sewer, and then the self-propelling duct-making machine is used to line the duct with the profile and to form a new spiral pipe in a continuum in the almost same geometry as the existing duct (needing restoration) (Fig. 1). In the next step, special mortar is filled between the existing pipe and the newly formed pipe to consolidate the two as a composite unit (Photos 1 and 2).

The SPR composite pipe thus formed makes it possible for aged and deteriorated ducts suffering cracking and corrosion to be

restored to a level equivalent to or better than a new pipe. More economical and superior both in work period and costs than the Cut & Cover Method, the SPR method has proven to be applicable in cases where wastewater is allowed to flow down, as far as the water rate is a certain level or less.

Future issues and approaches

This SPR method, intended for reconstruction of non-circular sewer pipes in service, has been widely employed for sewer pipes currently in service in Japan. Until the end of FY 2014, 987 km of sewer pipes had been satisfactorily restored nationwide including 584 km in the 23 wards of Tokyo. Also, in 13 countries including the US and Singapore we have restored about 111 km of sewers. In the future, we want to develop innovative approaches and techniques required to solve various issues arising out of sewerage systems and facility obsolescence in the Tokyo area.

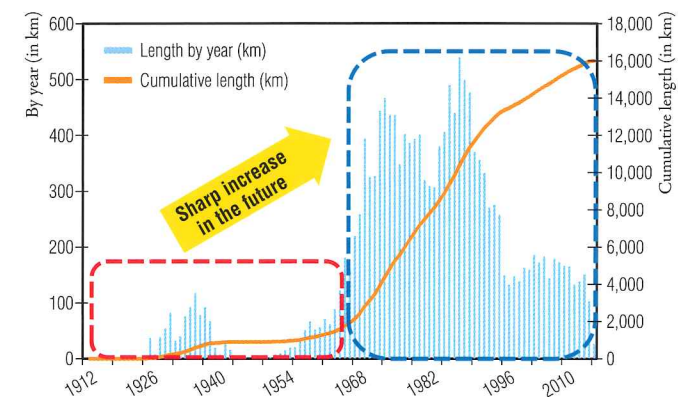

Fig. 1 Total length of reconstructed sewer pipes in the 23 wards of Tokyo by year



Photo 1 Reconstruction (in the pipe)



Photo 2 After restoration

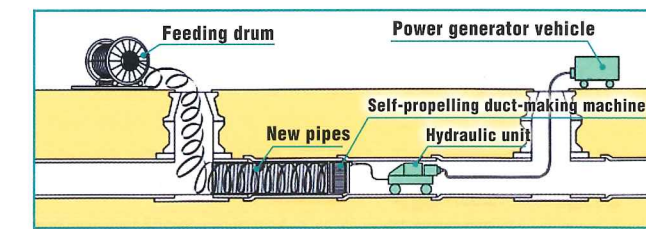

Fig. 2 How to construct sewer pipes

Construction of a Long TBM Tunnel with High Overburden, Water Ingress and Hot Rocks

- Pahang-Selangor Raw Water Transfer Tunnel, Malaysia -

Takashi KAWATA ▶ Director, Civil Engineering Technology Division, Shimizu Corporation



Fig. 1 Longitudinal section

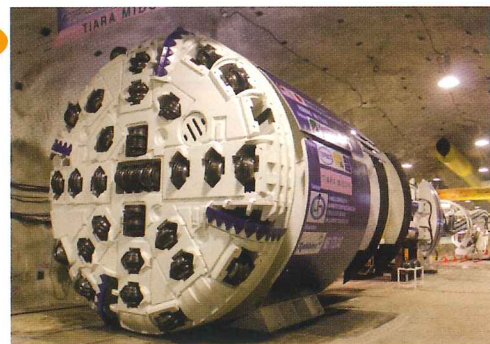

Photo 1 Tunnel Boring Machine

The Pahang-Selangor Project is the construction of a long raw water transfer tunnel to link the states of Pahang and Selangor in Malaysia. The tunnel is 44.6 km long (Fig. 1) and 5.2 m in diameter, one of the largest infrastructure projects in Asia. The project, when completed, will have the capacity to relieve the shortage of water for the daily needs of residents as well as industrial needs in Kuala Lumpur and, in the future, in the surrounding areas (water supply capacity of 1.89 million m³/day).

During the process of tunneling, we encountered heavy groundwater ingress of 10 m³/min, rock bursts, hot rocks, and in some areas, were forced to advance through large fault zones.

Geology

The geology of the tunnel was mainly composed of hard granite of a uniaxial compressive strength of 150 N/mm² to 200 N/mm², but included 6 major fault zones and 21 lineaments. The maximum overburden was 1,246 m, and the overburden exceeding a depth of 1,000 m extended 5 km.

Hot rocks exceeding a temperature of 50 deg. C were found in the high overburden depth of 5 km and the maximum temperature of the rocks was 55 deg. C.

High performance Tunnel Boring Machine

We employed the Main Beam Tunnel Boring Machine (TBM) for this project. The TBM for this project was equipped with a capacity 30% stronger in thrust force and a larger cutter head torque than similar past projects (Photo 1).

The thrust force and cutter head torque required of TBM was larger than the resistance force of the rock and soil in the TBM's construction site and its surroundings. A probe drilling machine was installed on the TBM, for probe drilling and drilling drain holes.

Fiber-mortar spraying system

The spraying of fiber mortar at an earlier stage may offer a very effective support for poor geology, which is prone to cause ground collapses after the passing of the TBM cutter head. This was the first project in which the fiber mortar spraying system made in Japan was used at an overseas construction site. The

characteristics of the fiber mortar and the spraying system are as follows.

Fiber mortar:

- Near-zero rebound
 - Good bonding
 - Development of a high early strength
- Spraying system:
- Being compactly arranged (Photo 2)



Photo 2 Fiber mortar spraying equipment mounted on TBM

With the fiber mortar-spraying system, we could successfully overcome the safety difficulties arising from the presence of large fault zones.

This system also proved to be effective preventing rock pieces flying out in the rock burst area where such risks existed.

Tunneling underground with significant ground water ingress

The TBM-1 section was affected frequently by large ground water ingress. The TBM-1 tunnel section was excavated downward (gradient 1/1900). Therefore, it was exposed to the danger that the TBM machine could be submerged.

A topographic map representing possible water ingress was drawn up in order to provide adequate dewatering facilities at relevant places (their pumping capacities, although originally 10 m³/min, were changed to a range of 20 m³/min → 31.5 m³/min); by doing so, we were able to avoid heavy ground water ingress.

Even if a 10 m³/min ingress occurred at the cutting face by TBM, the tunneling machine could continue excavation, because the site was drained sufficiently by using a pump with a large capacity of 55 kW.

Tunnel construction in an underground environment at high temperatures

In the TBM-2 section, there was an area in the tunnel where temperature rose to 43 deg. C due to hot rocks. In this environment, continuing the excavation was very difficult. To solve this problem, we used a series of cooling systems as follows:

- Water-cooled air-cooling system for TBM machines
- Passenger car with water-cooled air conditioner
- Water-cooling system installed on the ground surface.

Successfully Joining Tunnels at Great Depths and Under High Water Pressure Relying on Deformation Analysis

- Second Tameike Sewer Trunk Line, Tokyo -

Kenji OGURA ▶ Director, Second Construction Section, Second Core Facilities Reconstruction Office, Bureau of Sewerage, Tokyo Metropolitan Government

Introduction

In recent years, the metropolitan area of Tokyo has experienced flood damage during torrential rains, especially in some parts where the existing sewer ducts had insufficient discharge capacity. The Bureau of Sewerage of the Tokyo Metropolitan Government has been faced with the urgent necessity of taking actions to prevent such flooding damage.

The system in this area is a combined sewer type which, when the rain exceeds a certain level, allows rainwater combined with waste water to flow into the moats of the Imperial Palace and the Tsukiji River, which causes further deterioration of water quality. To alleviate this problem, the trunk sewer duct to the 2nd Tameike Sewer Trunk Line was planned, in order to minimize flooding damage and improve water quality.

Summary

The 2nd Tameike Sewer Trunk Line is a tunnel with a total length of 4,512 m, which is to be built at great depths of approximately 40 m underground. The tunnel is composed of an upstream segment (when completed, 6,500 mm in inner diameter × 1,995 m in length) and a downstream segment (8,000 mm in inner diameter × 2,517 m in length) (Fig. 1).

The project is intended to connect, through artificially frozen geology, a new underground downstream duct with the in-service trunk duct on upstream side.

There was a fear that during the boring, the shield machine might warp, causing the surrounding frozen earth to be separated from the shield machine. To alleviate this fear, we conducted a deformation analysis to reduce the displacement of the shield tunnel to as close to zero as possible, and at the same time, implemented measures to prevent deformation by determining the area to be frozen.

Construction conditions

The place where the upstream and downstream segments were to be joined was located just under a subway station, making it difficult to build a shaft by the cut and cover method to connect the two segments. The in-situ overburden was approximately 40 meters, and in addition, the project was faced with the difficulty to connect the two segments underground under high water pressure of 0.4 MPa.

Preliminary study and construction control

For connecting the two ducts, we decided to use a ground freezing technology which has excellent capability to stop water flow, as well as high strength and integrity. The shield machine, when operating at great depths and under high water pressure, involves the risk that the skin plates of the shield machine may deform suddenly and cause the gap between the machine and the frozen earth. On the other hand, when the frozen earth surface is warmed and melts, ground water may gush inside the tunnel. For these reasons, we took the three actions which follow:

- (1) To prevent the skin plate from separating from the frozen earth, deformation analysis was conducted. From the results thereof, a measure to control deformation (providing supports inside the shield machine) was put in place to minimize the convergence of the shield machine.
- (2) Implementation of strict temperature control to prevent melting of frozen earth.
- (3) A water storage reservoir and emergency power generator were installed in preparation for water cut-off and power failure during the construction, and temporary walls were installed to prevent secondary disasters. Emergency evacuation drills were conducted repeatedly.

Conclusion

Generally, two shield ducts are connected via a shaft especially provided for this purpose. However, in the central area of a large city, it has become difficult to acquire shaft sites as years pass by. The project was planned not only at a location immediately under the subway station of vital importance, but also located great depths underground and under high water pressure, as well in a severe construction environment involving a lot of embedded facilities.

Should an accident occur, it would have a significant impact on city activities. For this project, with cooperation of the project owner and contractor, we adopted the measure of controlling deformation, based upon the deformation analysis, and by establishing an optimal freezing zone to prevent the shield machine from deforming, we were able to complete the project safely.

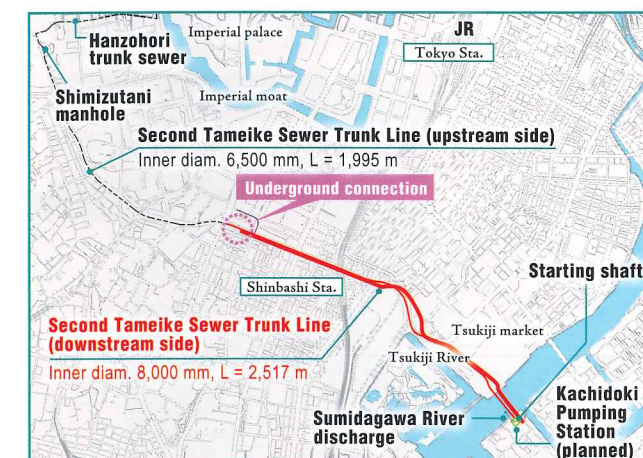

Fig. 1 Overall view of the Second Tameike Sewer Trunk Line

Solutions to Deal with Soil Contamination in Construction of the Narumi Utility Tunnel (Shield)

Kazuyoshi TANAKA ▶ Deputy Chief
Aichi National Highway Office, Chubu Regional Bureau
Ministry of Land, Infrastructure, Transport and Tourism



This paper presents an example of construction of a utility tunnel in Nagoya City, Aichi Prefecture, in which Class I Specified Toxic Substances (also known as volatile organic compounds (VOCs))* caused soil contamination (hereinafter referred to as "VOCs soil contamination"), and the decontamination treatment at the shield face.

The utility tunnel was bored by a mud pressure shield machine with an external diameter of the segments = 7,300 mm, internal diameter of the segments = 6,700 mm, and a total excavation length of approximately 3 km.

In a part of the excavation section, there was a zone where soil and groundwater were contaminated with trichloroethylene (TCE) used as an industrial detergent and cis-1,2-dichloroethylene (cDCE) produced in the process of spontaneous degradation of TCE in the ground. There were concerns that the pollutants may become volatile once the excavated soil was discharged and disperse, thus exacerbating the work environment and causing a negative impact on the environment of the area surrounding the worksite. This necessitated VOCs decontamination of sediment discharge, and we sought technology proposals for such decontamination measures.

We considered the standard procedure of decontamination with quicklime in plant conditions, but eventually decided to adopt the proposed Mild Fenton Method for soil decontamination at the shield face.

The conditions for adopting this method in excavating VOCs-contaminated soil are listed in (1) through (3) below.

- (1) It enables prompt treatment of volatile TCE in a safe and reliable manner.
- (2) The negative impact on the work environment in the shield and the environment of the area surrounding the worksite is kept under control.
- (3) Consideration is given to prevention of dispersal in the ground.

Under the Mild Fenton Method, hydrogen peroxide and a biodegradable catalyst are injected into the tunnel face and screw in the course of excavation, and TCE is treated in-situ by promptly degrading it into carbon dioxide, water, and chloride ions, which are non-toxic. By adopting this method, it was possible to keep under control the impact on the ground and the dispersal of VOCs during transportation on the belt conveyor inside the shield and at the sediment discharge plant, as well as the impact on the environment of the surrounding area.

Figure 1 displays an overview of the decontamination measures. The hydrogen peroxide and biodegradable catalyst, which are used as decontamination agents in the Mild Fenton Method, are stored in an aboveground plant and are transported via pipes to the shaft below, where they are temporarily stored in tanks placed on platform trucks inside the shaft. The tanks are then transported by a battery locomotive to the shield device trailing carriage and are injected using pumps into the excavation face and the secondary screw.

Figure 2 shows the decontamination-related construction facilities inside the shaft. The hydrogen peroxide and biodegradable catalyst were injected into the excavation face and the screw using injection pumps installed on the trailing carriage.

We took and analyzed samples of the muck discharged on the belt conveyor during excavation. The results demonstrated that all analyzed values were lower than the decontamination control values, and the impact on the work environment and the environment of the area surrounding the worksite was kept under control in the process of excavation.

*Class I Specified Toxic Substances: a class of volatile organic compounds in the category of specified toxic substances, which easily evaporate.

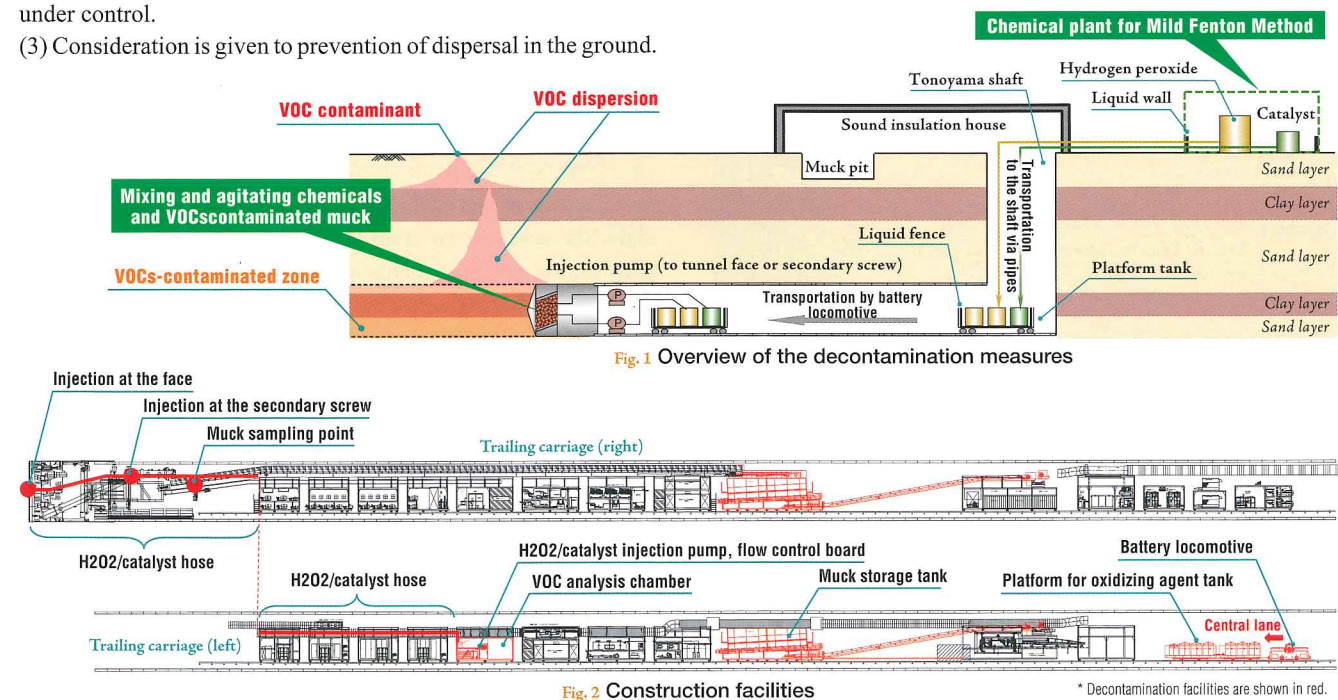

Observational Method of Shafts in the Horonobe Underground Research Center

Tomoo FUJITA ▶ Deputy Director
Sector of Decommissioning and Radioactive Wastes Management,
Horonobe Underground Research Department,
Japan Atomic Energy Agency



Introduction

As part of the research and development program for geological disposal of high-level radioactive waste, the Japan Atomic Energy Agency has initiated the Horonobe Underground Research Laboratory (Horonobe URL) Project to study soft sedimentary rock. The planned elements of the Horonobe URL include a ventilation shaft (4.5 m in diameter) and East and West Access Shafts (6.5 m in diameter), and experimental galleries/niches at depths of 140, 250, 350 and 500 m (Fig. 1). As of the end of June 2014, the Ventilation and East Access Shafts had reached depths of 380 m, the West Access Shaft had reached a depth of 365 m, and experimental galleries at depths of 140, 250 and 350 m had been completed.

The galleries in Horonobe URL were excavated in a formation of diatomaceous mudstone (Koetoi Formation) and siliceous mudstone (Wakkanai Formation). Both formations are classified as soft sedimentary rock. The uniaxial compressive strength of both formations ranges from about 5 to 25 MPa. The Ventilation

Shaft and West Access Shaft were excavated using a roadheader in order to prevent damages on the excavated wall during shaft sinking. The shaft was excavated with a cyclic procedure and auxiliary supports were also installed. This is the first time these methods for shaft sinking in soft sedimentary rock have been employed in the world. Figure 2 shows a photograph of the excavation apparatus. However, the East Access Shaft was excavated by drill-and-blast method.

Observational method for shaft sinking using a "3D geological structure/construction data visualization system"

In the Horonobe URL project, a "3D geological structure/construction data visualization system" has been employed to facilitate observational method because no studies have been found regarding the construction of underground facilities at depths greater than 300 m in sedimentary formations. Using this system, fracture mapping conducted at each excavation depth, measurement data, construction data and prediction analysis results are visualized and integrated comprehensively as the excavation proceeded. The system assisted clearer understanding of the behavior of the rock mass and the support, consequently improving construction safety.

Figure 3 shows an example of the application of the system to shaft excavation below a depth of 250 m. A potentially hazardous fault was identified by visualizing and integrating the results of the borehole televiewer survey, the seismic reflection survey, and the grouting operation. The lining interval in the fault zone was then revised on the basis of 3D examination. The excavation was successfully completed to a depth of 350 m while ensuring stability of rock mass around the shafts and preventing failure of the support system.

Through the project, it has been confirmed that the system contributes to a successful construction by the observational method in shaft excavation.

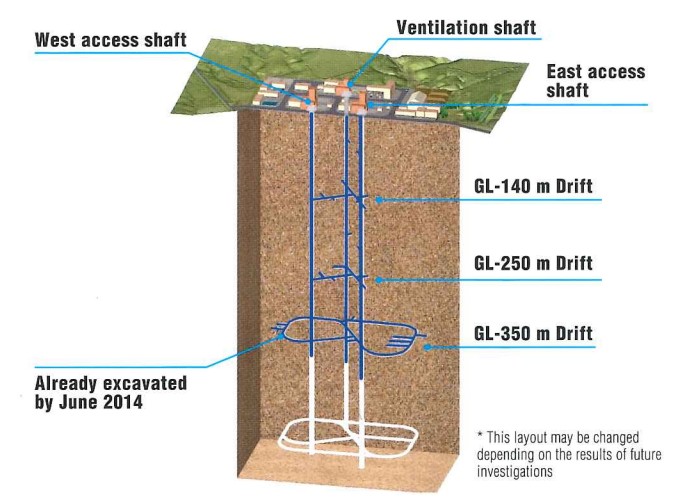

Fig. 1 Layout of the Horonobe Underground Research Laboratory



Fig. 2 Photo of the excavation apparatus (roadheader and scaffold) used for sinking a shaft.

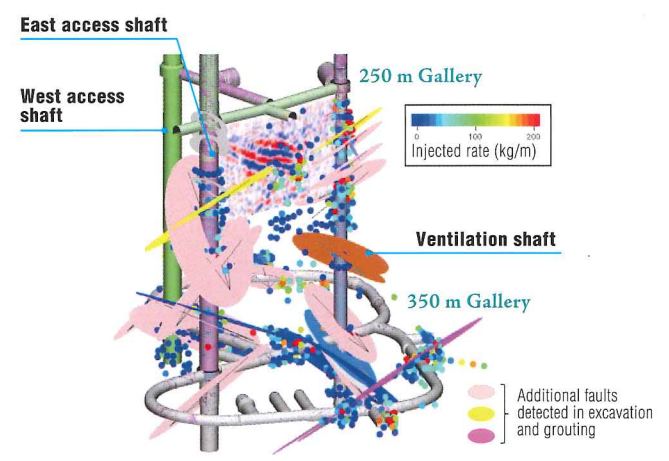

Fig. 3 3D visualized data (distribution of faults, volume of injected grout material and results of seismic reflection survey) in the Horonobe URL between 250 m and 350 m in depth.

Rapid Construction Using Long-hole Blasting in a Small-section Tunnel

Masatake OHASHI ▶ Professor, Institute for Cosmic Ray Research, The University of Tokyo
 Shuichi SAITO ▶ Deputy Manager, Facilities Construction Project Group, Facilities Department, The University of Tokyo
 Noriaki HANADA ▶ Director, Kamioka Tunnel Construction Office, Kajima Corporation



The project for construction of Large-scale Cryogenic Gravitational Wave Telescope (LCGT) facilities of the University of Tokyo (Institute for Cosmic Ray Research) is a project by the University of Tokyo with the goal of creating and maintaining an experimental space and environment for the LCGT plan. Specifically, the project includes excavation of two orthogonal straight tunnels with a length of 3 km (X-arm tunnel and Y-arm tunnel) into the Kamioka Mine in Gifu Prefecture, a location that is characterized by extremely low seismic noise levels and stable temperature and humidity, and installing various gravitational wave detection instruments, such as laser interferometers (3 km × 2).

These tunnels will host experimental facilities for detection of gravitational waves, a phenomenon whose existence was predicted by Albert Einstein on the basis of his theory of general relativity. In order to put them into use for research purposes as quickly as possible, it was necessary to build two long tunnels with a total excavation length of 7,697 m (excavation area of 15 m²) within two years. The construction work involved some severe procedural restrictions, but we aimed to complete it within the designated construction period by adopting long-hole blasting in the excavation process.

Long-hole blasting is utilized frequently in Europe and the United States as the geological conditions there often feature homogenous and solid bedrock. In Japan, on the other hand, the geological conditions lack homogeneity, so there are relatively few examples of boring with long-hole blasting as compared with other countries. In this project, the tunnels had to be constructed rapidly, and for most parts the bedrock was assumed to be hard and homogenous, so we adopted long-hole blasting. Eventually, we broke the national record for excavation speed by the NATM method, achieving a rate of 359 m per month and a rate of 660 m per month in total for the two tunnels that started from a single work shaft.

In the rapid construction

of a small-section tunnel with an excavation area of 15 m² (excavation width of 4 m), we placed importance on the following four points.

- (1) Adoption of long-hole blasting for small sections
- (2) Efficient mucking operations by increasing the size of equipment
- (3) Ventilation to maintain a good environment inside the tunnel
- (4) Understanding ground conditions ahead of the tunnel face through observational construction

The most important issue in the long-hole blasting in particular is how to improve the advance rate (the length of excavation for one blast / drilling length). Compared with ordinary blasting, more than twice as much blasting powder was used, but the shortening of processes achieved by faster excavation speed can sufficiently make up for high blasting powder costs.

In order to boost the advance rate at the worksite of this project, laser verification and other technologies were adopted to improve drilling precision, overbreak was reduced, and the construction was carried out through long-hole blasting (with advance length of 4.0 m per blast).

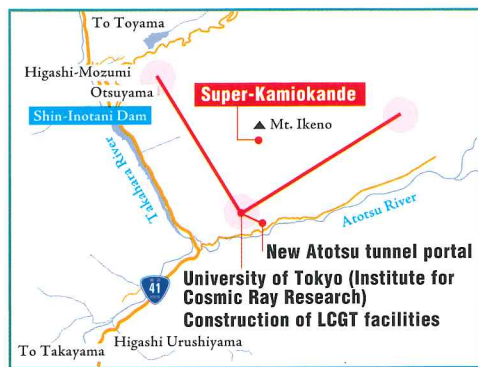

Fig. 1 Tunnel location map

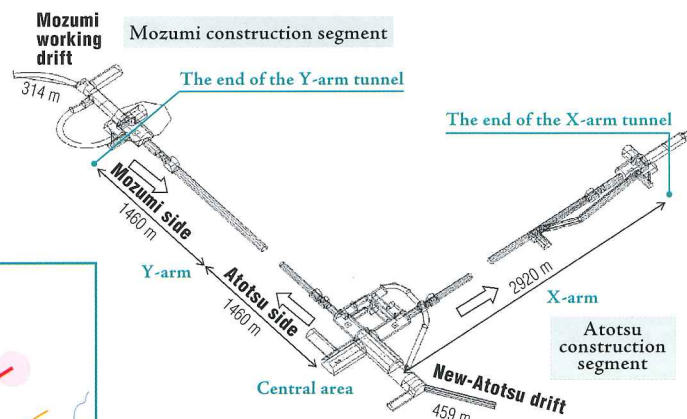

Fig. 2 General view of the facility

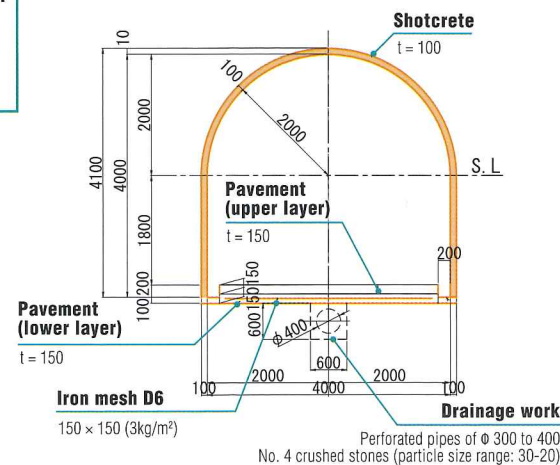

Fig. 3 Standard cross-section view



Photo 1 Long-hole blasting status

New Technique to Inhibit Heaving of Road Surfaces in Tunnels without Closing Traffic

- Nagano Expressway, Ipponmatsu Tunnel -

Hiroshi KAGAMI ▶ Chief
 Nagano Construction Office, East Nippon Expressway Company Limited



The Ipponmatsu Tunnel is a 3,200 m long, four-lane tunnel on the Nagano Expressway. It was constructed during 1990 and 1991 and put into service in March 1993. In 1996, heaving of the road surface appeared at a no-invert-concrete section due to external forces working on the tunnel and slight deformation is still continuing. To cope with this kind of deformation, the placement of an invert is generally known to be an effective measure. However, it is necessary to close road traffic for a long time to place invert concrete. To avoid such inconvenience, a new technique, "curved box-propelling system," was developed to place invert concrete under the road in order to minimize traffic interruption. Details of this process are given below.

History of deformation in the Ipponmatsu Tunnel and measures taken

At the initial stage of the heaving, deformation was relatively small and not considered to be an urgent problem that needed to be repaired. Given the width of the tunnel, it was impossible to divide the road width into two sections to allocate half to traffic. For this reason, a new approach was needed to manage extensive repair of the road surface without closing traffic. A curved box-propelling system was thus developed for the placement of invert concrete (Fig. 1).



Photo 1 Boring machine (twin header)



Photo 2 View of the box in place (placement of the steel box)

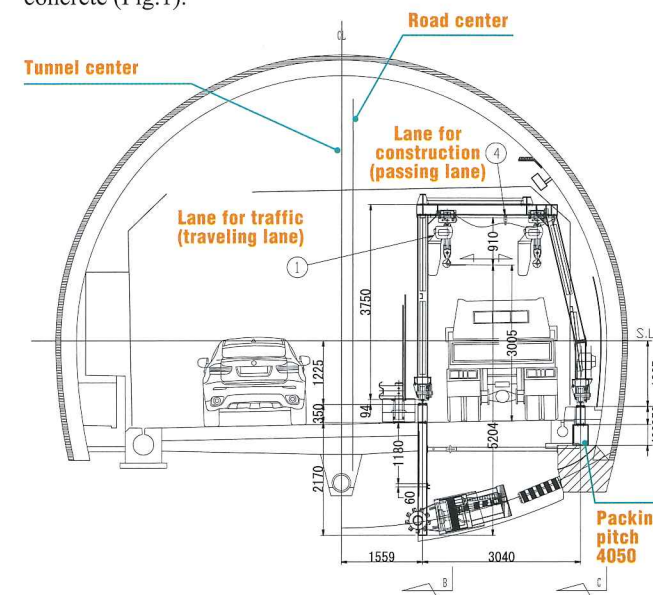

Fig. 1 Curved box-propelling system

Curved box-propelling system

The system is characterized by a twin header (Photo 1). The boring machine is a universal type and able to cope with a variety of geological conditions and widely used for soft rock excavation. Being equipped with a twin header, which is flexible to be able to move over a wide range, the excavation machine can be easily transported through the box without using special equipment. The curved box-propelling system is characterized by the following: the shell of the box is positioned in advance at the center where

traffic control is difficult; then concrete is filled into the box; along the outer circumference of the box, back-filling grout is poured to form an invert (Photo 2).

Results of construction

Construction started at the end of August of 2013, just after the busy vacation season. First, the box-propelling system was introduced from the passing lane side to form the central part and the right half of the invert concrete. Second, the traffic was shifted to the passing lane and the concrete invert of the left side was constructed to complete the circular cross-section.

As planned originally, the project was completed in about three months, by the end of November, before beginning of the snow season. During the period assigned, construction produced no convergence, settlement of lining crown and road surface, or excessive stresses signaling risk to workers. After completion, the road surface and ground around the tunnel have been observed for one year and no displacement has been recorded. Therefore, the invert thus provided was confirmed to be an effective measure for control of deformation.

21 New Rapid Non-core Drilling System for Long Distances

Satoshi ITO ▶ Deputy Manager
Civil Engineering Technology Division, OBAYASHI Corporation

When the overburden is deep and aquifers are predicted to exist ahead of a tunnel face, dewatering is essential to excavate the tunnel safely preventing sudden bursts of high-pressure water inflow. By using a new rapid non-core drilling machine for long distances (L=150 m) with a water powered down-the-hole hammer, it is possible not only to investigate the geological condition ahead of the tunnel face quickly but also to dewater in order to prevent a sudden water burst during tunnel excavation.

Rapid drilling with Water Powered Hammer

In the water powered down-the-hole hammer, the piston directly strikes the drill bit, producing an oscillating movement under pressurized water (up to 18 MPa).

Since the piston directly contacts the drill bit, the loss of impact energy is small, and it is suitable for a long distance drilling.

In the case of an 8 m guide cell provided on the dedicated non-core drilling machine, the use of a 6 m drilling rod makes it possible to reduce the frequency and the time spent in the joining of drilling rods by half, compared with the conventional machine.

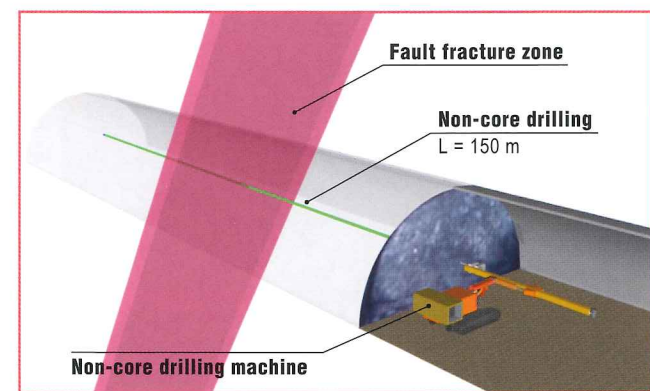

Fig. 1 Schematic diagram of the new exploration system



Photo 1 New drilling machine

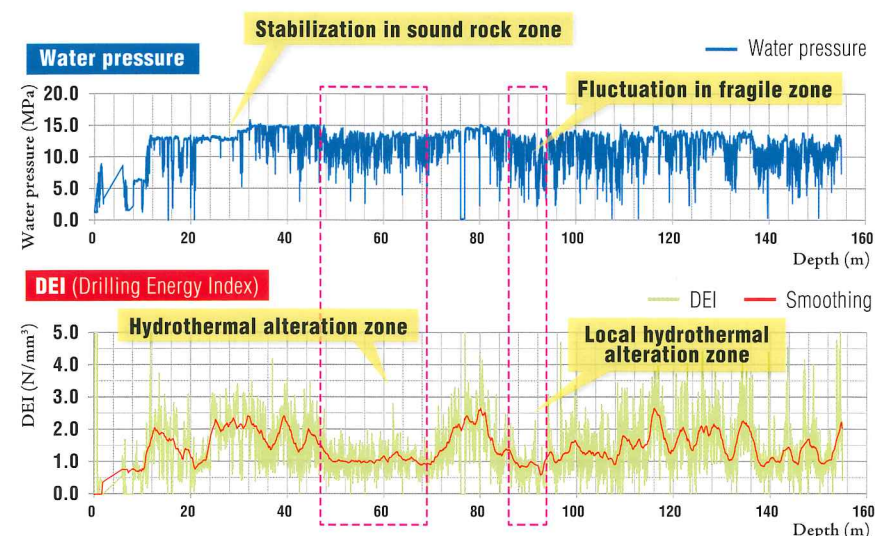

Fig. 2 In-situ observed data (above: water pressure, below: drilling energy index)

Mechanism how to predict geological conditions

Paying attention to the mechanical function of the water powered hammer, a new parameter has been introduced based on the impact energy.

This approach enables to detect fault fracture zones and classify the ground ahead of the tunnel face.

The drilling energy required for a drilling unit length is directly proportional to the value "P (water pressure) × f (number of blows per unit drilling length)". Thus, the value was confirmed to define DEI (Drilling Energy Index) and used to predict the geological conditions ahead of the tunnel face.



Photo 2 Detail of drill bit

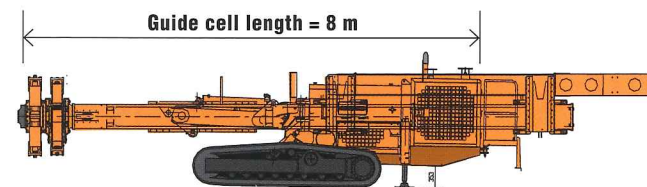

Fig. 3 Side view of the new drilling machine

22 Development of a Sophisticated SB Joint for Shield Tunnels

Ikuo FUJIKI ▶ Executive Director,
Metro Development Co., Ltd.

In recent years, shield tunneling projects have been required to shorten construction period, improve segment durability and seismic safety, and reduce material consumption in order to reduce environmental impact. To meet these requirements, the screw bolt (SB) joint was developed to serve as a ring joint for the segment.

Structure of the SB joint

The SB joint consists of female and male parts. The female part is composed of a ductile case, a spring, a group of eight small screw bolts, a taper ring, a seismic isolation ring, and a front cover. The male part is a threaded bolt connected with the deformed steel rod. When the quakeproof function is not required, the female coupling may be cheaper without quakeproof ring, having a monolithic structure of a taper ring and a front cover.

Various functional features of the SB joint

The SB joint is a one-touch type that makes it possible to shorten the manufacturing process by 23% compared with a conventional bolt joint. It is also economical because the manufacturing cost can be reduced by 10% compared to a conventional joint by using available products such as small bolts.

The female component contains a seismic isolation ring to prevent compressing forces, thus enabling increase of quakeproof performance in the longitudinal direction of the tunnel.

The seismic isolation ring is made of either of two materials; urethane or mechanical elastic material. On the surface of a bolt, there is a portion where a particularly large shear force applies, but this portion is designed with a larger circumference than other parts for greater shear resistance. Although the bolt used for this project is basically M24 in size, its circumferential diameter and wall thickness are partially enlarged to increase the shear strength appropriately, without changing the whole shape of the joint. Since the ductile case and its content are not connected, it is possible for the segments to be assembled more flexibly. The joint, thus designed, not only adds alignment functions that a conventional one-touch type joint does not have, but also minimizes damage to the segment, leading to greater endurance of segments.



Evaluation of the SB joint

SB joints have used in more than 30 projects in Japan, and in the access portion of the shaft as part of a railway extension project in Incheon Airport Terminal 2 in Korea. As mentioned above, the SB joint is provided with multiple functions of innovative technology, and has been used in various construction projects.

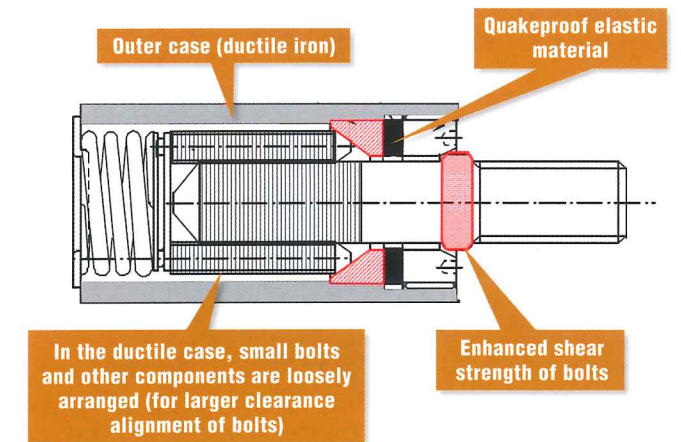

Fig. 1 Schematic diagram of the SB joint

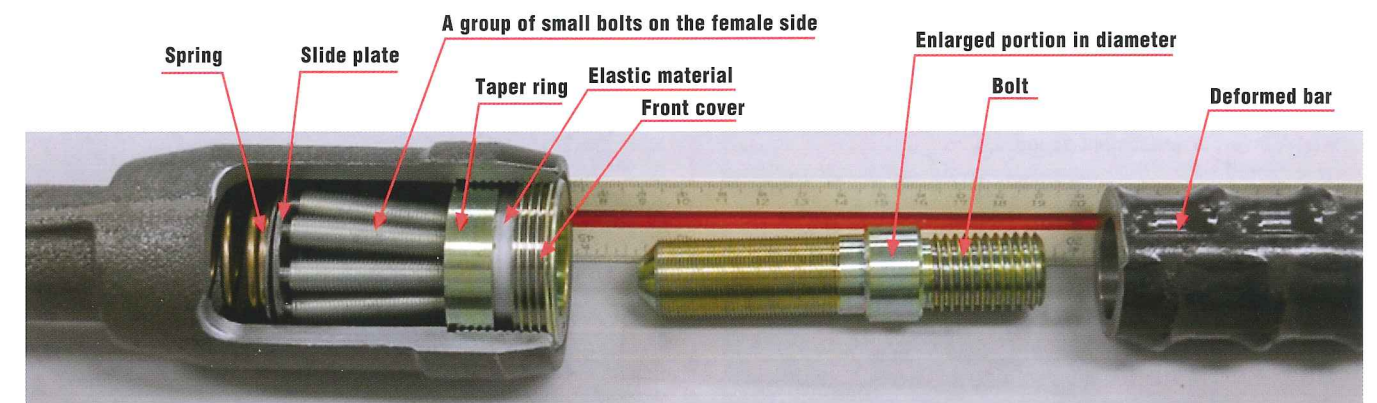

Fig. 2 Structure of the SB joint

Invert Displacement Gauge

- Ground swelling measurement during tunnel construction -

Hideo KINASHI ▶ Deputy General Manager
Civil Engineering Technology Division,
OBAYASHI Corporation

In railway and road tunnels in service, incidents of ground swelling have occurred frequently, causing difficulties in maintenance. To avoid these kinds of problems during the construction of a tunnel, it is critical to watch and identify a potential heaving of the roadbed and to confirm that the displacement inducing such heaving has completely settled.

Since during tunnel construction, there is a continual traffic of heavy construction machines and dump trucks, it is difficult to provide reference marks on the roadbed to measure the amounts of heaving. To resolve this problem, we have developed an invert-displacement gauge able to automatically measure ground swelling with high precision, which when used, is embedded into the roadbed to prevent the effect of operating vehicles. As illustrated in the Figure 1, the water pressure gauge set in the roadbed and a water reservoir serving as a reference are directly connected through a water-filled PVC pipe enabling measurement of the amount of ground swelling by keeping the water level in the reservoir constant. Photo 2 shows a warning with a LED light which varies in color, with the heaving level. Moreover, the instrumentation is installed in a protective pipe for repeated usage.

Up to now, we have already applied this system in three road tunnels to monitor heaving of roadbeds.

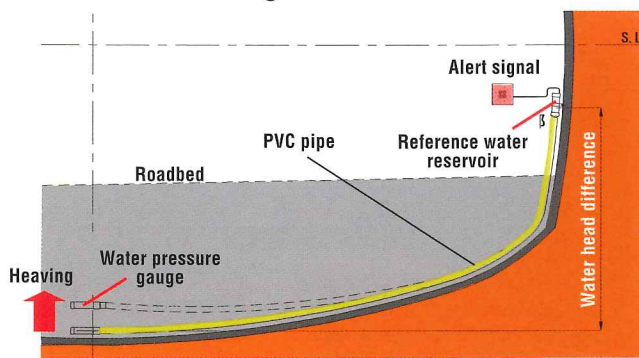

Fig. 1 Schematic drawing of invert displacement measurement

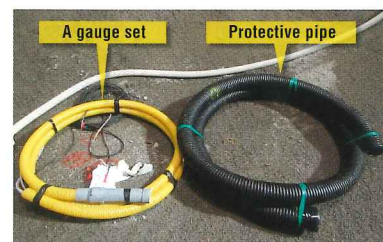

Photo 1 Invert displacement gauge

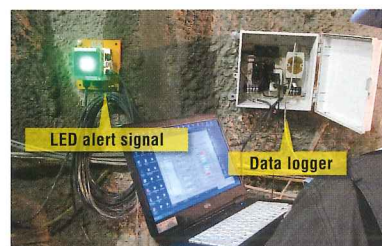

Photo 2 Data logger and LED alert signal

New 3D Deformation Measuring System Combining a Laser Scanner and Image Processing Technology

Atsushi UNEDA ▶ Chief Engineer
Civil Engineering Design Division, Kajima Corporation

Every tunnelling project requires measurements of tunnel displacement in order to manage risks. Normally, a total station is used to measure displacements of multiple points where a reflector such as a prism or sheet target is installed. However, this survey method tends to overlook local displacement and misread the deformation mode of a tunnel because it is impossible to determine displacements at places where the reflector is not installed.

Recently, a 3D laser scanner has been utilized to measure deformation of tunnels. However, it cannot always measure the displacement of the same point because it cannot identify measuring points each time nor track displacement at specific points continuously.

Therefore, Kajima invented a methodology that identifies specific points in laser scanning data by using the image processing technology "template matching". This can provide us with time-lapse 3D displacements of any points needed on the tunnel wall.

Through this system we can identify the overall deformation over time of the tunnel wall, guaranteeing safe excavation for the three tunnelling projects in Japan including the Kitanomine Tunnel, the Mitasaka Tunnel and the Kooroshi Tunnel.

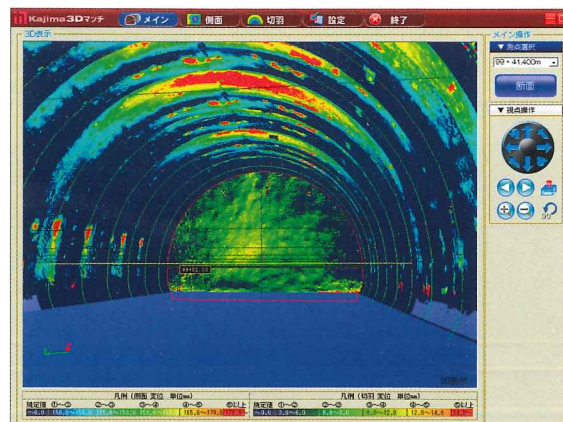
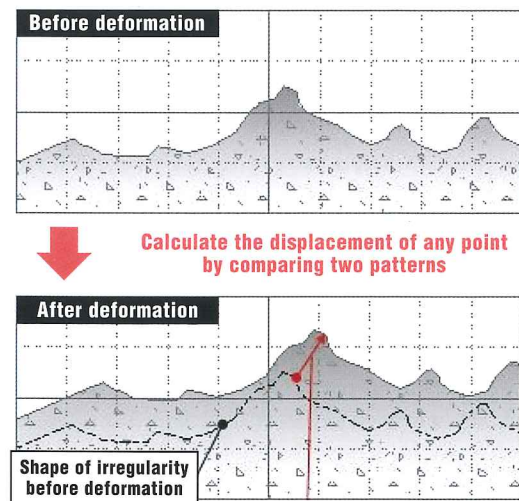

Fig. 1 3D matching

General Aspects of Tunneling in Japan

Trend of Construction Investment in Tunnels and Underground Spaces

The total amount of construction investment in tunnels and underground spaces in Japan increased rapidly until 1995, but since 1995 it has been on the downturn due to the continuing government curbs on public investments. However, from 2011 it had been flat because of reconstruction demands after the Great East Japan Earthquake, and in 2014 it tended to increase drastically again due to improvement projects of the transportation network for the coming 2020 Tokyo Olympic Games. Fig. 1 shows trends in volume of work under construction, divided according to the purposes of tunnels and underground spaces in Japan.

Fig. 2 shows the makeup of contracted amounts of different project purposes in 2014. The largest was road at 62%, followed by waterways at 10%, railways at 7% and others at 20%.

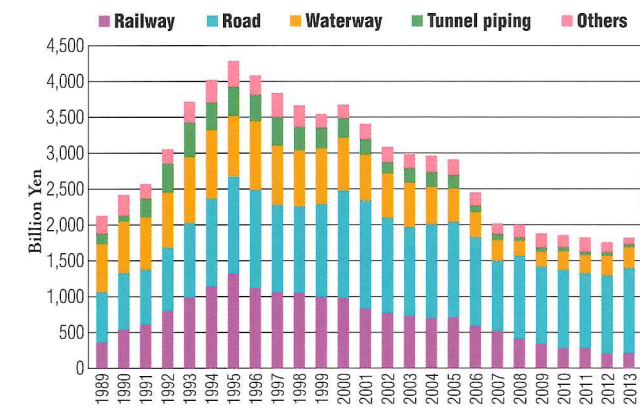

Fig. 1 Trend of construction investment in tunnels and underground space

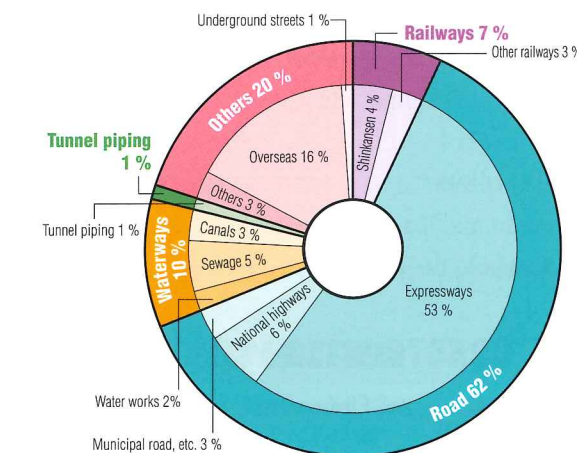

Fig. 2 Ratio of contractual amount by project purpose

Trends of Tunneling Method

Fig. 3 shows trends in the number of tunnel construction sections by tunneling method (conventional/NATM, shield method, etc.) and changes in their proportion. The ratio of the conventional method is the highest, accounting for 30% to 60% of the total and still increasing, followed by the shield method, leveling off in the range 20% to 30%. The ratio of pipe jacking projects has dipped, accounting for 9%, and the cut-and-cover has leveled off at around 5%.

The increase of ratio of projects by the conventional method is attributable to widened range of application of this method

because of technological development such as various auxiliary methods.

Fig. 4 illustrates the percentages of different construction methods and those of excavation methods. The conventional method accounts for 63% of the total, for which blasting is most frequent 60%. The shield method is 22%, which is subdivided into 26% for slurry shield and 71% for high-density slurry shield and 2% for earth pressure balanced shield.

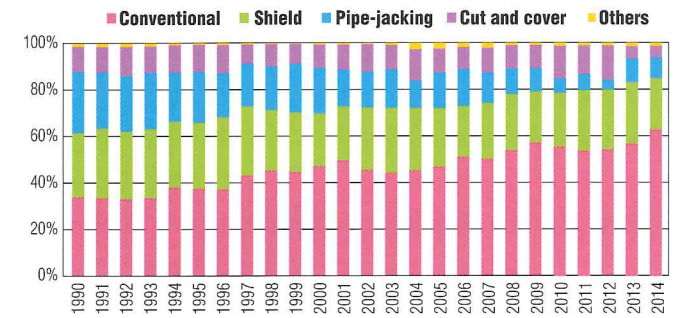

Fig. 3 Ratio of tunnel numbers by excavation method

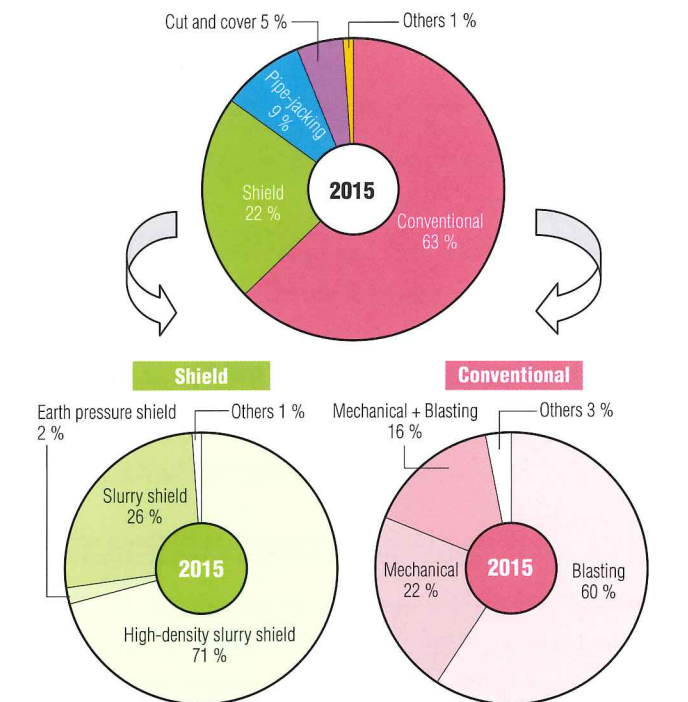

Fig. 4 Breakdown of construction and excavation methods

Domestic and Overseas Tunnel Construction by Japanese Contractors

Fig. 5 shows the contract amounts of domestic overseas tunnel construction projects by JTA member contractors.

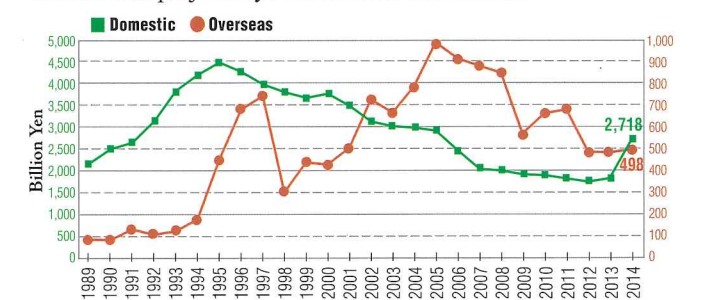

Fig. 5 Domestic and overseas tunnel construction by Japanese contractors

List of Members

Public Corporations, Local Authorities, Owner Companies and Associations

Central Nippon Expressway Co., Ltd.

2-18-19, Nishiki, Naka-ku, Nagoya, Aichi 460-0003
TEL: 52-222-3623
FAX: 52-232-3576
E-mail: engineering@c-nexco.jp
<http://global.c-nexco.co.jp>

East Japan Railway Company

2-2-2, Yoyogi, Shibuya-ku, Tokyo 151-8578
TEL: 3-5334-1288
FAX: 3-5334-1289
<http://www.jreast.co.jp>

East Nippon Expressway Co., Ltd.

Shin Kasumigaseki Bldg., 3-3-2, Kasumigaseki,
Chiyoda-ku, Tokyo 100-8979
TEL: 3-3506-0111
<http://www.e-nexco.co.jp/english/>

EXPRESS HIGHWAY RESEARCH FOUNDATION OF JAPAN

OJ Bldg., 2-11-10, Minamai-Azabu, Minato-ku,
Tokyo 106-0047
TEL: 3-6436-2100
FAX: 3-6436-2098
E-mail: soumu@express-highway.or.jp
<http://www.express-highway.or.jp>

Metropolitan Expressway Company Limited

1-4-1, Kasumigaseki, Chiyoda-ku, Tokyo 100-8930
TEL: 3-3539-9442
FAX: 3-3503-1806
<http://www.shutoko.co.jp/english/>

Tokyo Metro Co., Ltd.

3-19-6, Higashi-Ueno, Taito-ku, Tokyo 110-8614
TEL: 3-3837-7132
FAX: 3-3837-7112
<http://www.tokyometro.jp/index.html>

West Nippon Expressway Company Limited

18th Fl., Dojima Avanza, 1-6-20, Dojima, Kita-ku,
Osaka-shi, Osaka 530-0003
TEL: 6-6344-4000
FAX: 6-6344-7384
<http://www.w-nexco.co.jp/en/>

General Contractors

Fudo Tetra Corporation

7-2, Nihonbashi-koamicho, Chuo-ku,
Tokyo 103-0016
TEL: 3-5644-8500
FAX: 3-5644-8510
E-mail: doboku@fudotetra.co.jp
<http://www.fudotetra.co.jp/english/index.html>

HAZAMA ANDO CORPORATION

6-1-20, Akasaka, Minato-ku, Tokyo 107-8658
TEL: 3-6234-3600
FAX: 3-6234-3700
<http://www.ad-hzm.co.jp/english/index.html>

KABUKI CONSTRUCTION Co., Ltd.

3-31-5, Takada, Toshima-ku, Tokyo 171-8560
TEL: 3-3984-4114
FAX: 3-3984-6896
E-mail: takeda.mi@kabuki.co.jp
<http://www.kabuki.co.jp/>

KONOIKE CONSTRUCTION CO., LTD.

3-6-1, Kitakyuhoujicho, Chuo-ku, Osaka-shi, Osaka,
541-0057
TEL: 6-6245-6500
FAX: 6-6245-6508
<http://www.konoike.co.jp/>
* Contact form: <https://www.konoike.co.jp/english/request/index.php>

Kumagai Gumi Co., Ltd.

2-1, Tsukudo-cho, Shinjuku-ku, Tokyo 162-8557
TEL: 3-3260-2111
FAX: 3-5261-5576
<http://www.kumagaigumi.co.jp/english/index.html>

MAEDA CORPORATION

2-10-2, Fujimi, Chiyoda-ku, Tokyo 102-8151
TEL: 3-3265-5551
<https://www.maeda.co.jp/english.html>

OBAYASHI CORPORATION

Shinagawa Intercity Tower B, 2-15-2, Konan,
Minato-ku, Tokyo 108-8502
TEL: 3-5769-1303
FAX: 3-5769-1970
<http://www.obayashi.co.jp/english/index.html>

Okumura Corporation

2-2-2, Matsuzaki-cho, Abeno-ku, Osaka 545-8555
TEL: 6-6621-1101
FAX: 6-6627-5295
<http://www.okumuragumi.co.jp/en/>

PENTA-OCEAN CONSTRUCTION CO., LTD.

2-2-8 Koraku, Bunkyo-ku, Tokyo 112-8576
TEL: 3-3817-7181
FAX: 3-3817-7642
<http://www.penta-ocean.co.jp/english/index.html>

Sato Kogyo Co., Ltd.

4-12-19, Nihonbashi-honcho, Chuo-ku,
Tokyo 103-8639
TEL: 3-3661-0502
FAX: 3-3661-5473
E-mail: skip@satokogyo.co.jp
<http://www.satokogyo.co.jp/oversea/index.html>

SHIMIZU CORPORATION

2-16-1, Kyobashi, Chuo-ku, Tokyo 104-8370
TEL: 3-3561-1111
FAX: 3-3561-8672
<http://www.shimz.co.jp/english/index.html>

SUMITOMO MITSUI CONSTRUCTION CO., LTD.

2-1-6, Tsukuda, Chuo-ku, Tokyo 104-0051
TEL: 3-4582-3171
FAX: 3-4582-3247
<http://www.smcon.co.jp/en/corporate/index.html>

Takenaka Civil Engineering & Construction Co., Ltd.

1-1-1, Shinsuna, Koto-ku, Tokyo, 136-8570,
TEL: 3-6810-6223
FAX: 3-6660-6306
E-mail: overseas@takenaka-doboku.com
<http://www.takenaka-doboku.co.jp/en/>

TEKKEN CORPORATION

2-5-3, Misaki-cho, Chiyoda-ku, Tokyo 101-8366
TEL: 3-3221-2131
FAX: 3-3265-3776
E-mail: tk-doboku@tekken.co.jp
<http://www.tekken.co.jp>

The Zenitaka Corporation

2-2-11, Nishi-Honmachi, Nishi-ku, Osaka, 550-0005
TEL: 6-6531-6431
FAX: 6-6538-7900
http://www.zenitaka.co.jp/index_top_eng.html

TOYO CONSTRUCTION CO., LTD.

Aomi Frontier Bldg., 2-4-24, Aomi, Koto-ku,
Tokyo 135-0064
TEL: 3-6361-5462
FAX: 3-5530-2914
<http://www.toyo-const.co.jp/en/>

WAKACHIKU CONSTRUCTION, CO., LTD.

2-23-18, Shimomeguro, Meguro-ku, Tokyo 153-0064
TEL: 3-3492-0278
FAX: 3-3492-0680
<http://www.wakachiku.co.jp/en/>

Manufacturer and Trading Firms

Denka Company Limited

Nihonbashi Mitsui Tower, 2-1-1,
Nihonbashi-muromachi, Chuo-ku, Tokyo 103-8338
TEL: 3-5290-5363
FAX: 3-5290-5085
<http://www.denka.co.jp/eng/index.html>

FTS LTD.

7th Fl., Huli Kobunacho Bldg., 8-1,
Nihonbashi-kobunacho, Chuo-ku, Tokyo 103-0024
TEL: 3-6206-2220
FAX: 3-6206-2221
E-mail: info@fts-ltd.jp
<http://www.fts-web.jp/>

GEOSTAR Corporation

Frontier Koishikawa Bldg., 1-28-1, Koishikawa,
Bunkyo-ku, Tokyo 112-0002
TEL: 3-5844-1200
FAX: 3-5844-1203
E-mail: techinfo@geostr.co.jp
<http://www.geostr.co.jp>

Hokuriku Steel Production Co., Ltd.

888, Kitanoshin, Namerikawa-shi, Toyama 936-0806
TEL: 76-476-2155
FAX: 76-476-2177
E-mail: nozawa@hokuriku-kosan.co.jp
<http://www.hokuriku-kosan.co.jp/>

JAPEX CORPORATION

4th Fl., Shimbashi Chuo Bldg., 1-11-5, Nishi-
Shimbashi, Minato-ku, Tokyo 105-0003
TEL: 3-3506-9061
FAX: 3-3580-8244
E-mail: japex-staff@highjex.jp
<http://www.highjex.jp>

KATECS

1-3-3, Kamimaezu Naka-ku, Nagoya-shi,
Aichi 460-8331
TEL: 52-331-8821
FAX: 52-332-0164
E-mail: kondo-sizuo@katecs.co.jp
<http://katecs.jp/>

KFC LTD.

11th Fl., Shiba Park Bldg. B, 2-4-1, Shibakoen,
Minato-ku, Tokyo 105-0011
TEL: 3-6402-8251
FAX: 3-6402-8255
E-mail: iwama.hiroshi@kfc-net.co.jp
<http://www.kfc-net.co.jp/>

Mitsui Miike Machinery Co., Ltd.

2-1-1, Nihonbashi-muromachi, Chuo-ku,
Tokyo 103-0022
TEL: 3-3270-2005
FAX: 3-3245-0203
E-mail: sanki@mitsuimiike.co.jp
<http://www.mitsuimiike.co.jp/english/index.html>

Orica Japan Co., Ltd.

7th Fl., Toranomom Misu Bldg., 3-7-11, Toranomom,
Minato-ku, Tokyo 105-0001
TEL: 3-5777-4681
FAX: 3-5777-4682
E-mail: takeshi.yamada@orica.com
<http://www.oricaminingservices.com>

Specialty Contractors

DAIMARU-BOUON CO., LTD.

9th Fl., Tanaka Bldg., 2-10-15, Higashikanda,
Chiyoda-ku, Tokyo 101-0031
TEL: 3-5825-6700
FAX: 3-5825-6703
E-mail: info@daimaru-bouon.co.jp
<http://www.daimaru-bouon.co.jp>

SEIKEN CO., LTD.

1-15-17, Koishikawa, Bunkyo-ku, Tokyo 112-0002
TEL: 3-5689-2356
FAX: 3-5689-2363
E-mail: ueki-k@seikenn.co.jp
<http://www.seikenn.co.jp>

Consulting and Engineering Firms

CORE Institute of Technology Corp.

4th Fl., Osaka JA Bldg., 1-2-5, Nishi-Temma,
Kita-ku, Osaka 530-0047
TEL: 6-6367-2122
FAX: 6-6367-2322
E-mail: fukuda@coreit.co.jp
<http://www.coreit.co.jp>

Japan International Consultants for Transportation Co., Ltd.

9th Fl., Shin-kokusai Bldg., 3-4-1, Marunouchi,
Chiyoda-ku, Tokyo 100-0025
TEL: 3-6269-9878
FAX: 3-6269-9893
E-mail: hayasaka@jictransport.co.jp,
kishida@jictransport.co.jp
<http://www.jictransport.co.jp/jp/>

Metro Development Co., Ltd.

11-9, Nihonbashi-kodenmachi, Chuo-ku,
Tokyo 103-0001
TEL: 3-5847-7800
FAX: 3-5847-7821
<http://www.metro-dev.co.jp>

ORIENTAL CONSULTANTS CO., LTD.

Sumitomo Fudosan Nishi Shinjuku Bldg. No. 6,
3-12-1, Honmachi, Shibuya-ku, Tokyo 151-0071
TEL: 3-6311-7551
FAX: 3-6311-8011
E-mail: webmaster@oriconsul.com
<http://www.oriconsul.com/>

Metropolitan Expressway Group Companies support your road development and management



Metropolitan Expressway Group Companies of Metropolitan Expressway Co., Ltd, Shutoko Engineering Co., Ltd, Highway Technology Research Center and other affiliated companies can provide various road construction technologies and know-how gained through our long-term experience in the high-density Tokyo metropolitan area.



PLANNING & CONSTRUCTION



- Road construction technologies for various conditions.
- Project evaluation utilizing traffic demand prediction.

Our Group Companies' Engineering Consulting Service

INSPECTION & MAINTENANCE



- Methods of inspection, evaluation, and repair based on our long-term experience in road maintenance.

OPERATION & TRAFFIC MANAGEMENT



- Appropriate traffic control technologies according to your road network scale.
- ITS and ETC technologies to meet your needs.

Contacts



Metropolitan Expressway Company Limited

<http://www.shutoko.co.jp/english/>



International Affairs Division, Technical Consulting Department (Headquarters)

1-4-1 Kasumigaseki, Chiyoda-ku, Tokyo, 100-8930, JAPAN

E-mail: tokyo@shutoko.jp

Obayashi Technologies lead to High-Quality Results

Mechanised Tunneling

Obayashi has completed more than 600 TBM projects over the world under challenging geologies, and made several record-breaking successful results. In a recently invented URUP method, a TBM can be launched and arrived at ground levels, meaning it eliminates shafts and drastically improves safety conditions, cost, and time. Various shapes are now also available. Obayashi's wedge joint in combination with SFRC Segment gives you technical advantages resulting in improved productivity and water-tightness.

- Circular URUP TBM ①
- Non-circular URUP TBM ②
- Wedge joint ③
- High quality SFRC segment ③



Conventional Tunneling

With conventional drill & blast method, Obayashi has accomplished numerous records of achievement on many occasions and not limited to energy (Gas) stockpiling, road, and railroad. State-of-the-art technologies, including New Rapid Non-core Drilling System (see page 22), lead to safer working environment and rapid & high-quality delivery in various ground conditions from hard rock to soft rock & soil.

- Rapid investigation ahead of tunnel face ②
- Advanced tunnel design technology ①
- Rapid tunnel construction system ②
- Face stabilization technology ②
- High-quality tunnel lining technology ②
- Tunnel repair & reconstruction technology ③



Surface Tunneling

Obayashi responds to customers concerns with unique technologies such as Inclined-Braceless Excavation Support (IBES). In example, when using IBES, a horizontal shoring system can be eliminated and productivity will drastically improve with cost-saving coming from this technology, passed on to the client. Along with IBES, Obayashi provides many other options that are attractive to customers.

- Inclined-Braceless Excavation Support (IBES) ①
- Quadruple arch culvert tunnel ②
- Self-supporting retaining wall by improved ground ③
- Construction using precast elements ③
- Pneumatic caisson method ④



For 125 years, Obayashi Corporation has been contributing to the industry on various occasions. Customer satisfaction is a top priority that Obayashi pursues and is assured by Obayashi's comprehensive engineering services from conceptual design to construction, maintenance phases, and supported by in-house quality resources including Design & Technical Divisions, Technical Research Institute, Machinery Works, in addition to Field Project Management Groups. Please tell us your concerns and challenges.

