

INTRODUCTION OF HAIVAN PASS TUNNEL CONSTRUCTION PROJECT IN VIET NAM

Longest Highway Tunnel in South-East Asia

Nguyen Ngoc TRAN, General Director, Project Management Unit No. 85, Ministry of Transport, Vinh, Viet Nam

Nguyen Ngoc CANH, Deputy General Director, Project Management Unit No. 85, Ministry of Transport, Vinh, Viet Nam

Ichizuru ISHIMOTO, Project Manager, Nippon Koei Co., Ltd., Tokyo, Japan

General Location Map



Project Location Map



View of Hai Van Pass



Execution Agency

1) Organization Structure				
Organization	Name			
Financing Agency	Japan Bank for International Cooperation (JBIC)			
	L/A No. VNIV-5, March 26, 1997, Loan Amount: JPY 5.5 billion			
	L/A No. VNIV-6, March 30, 1999, Loan Amount: JPY 1.0 billion			
	L/A No. VNDX-4, March 29, 2002, Loan Amount: JPY 3.359 billion			
	Total: JPY 10.859 billion			
Executing Agency	Project Management Unit No. 85 (PMU85) under Ministry of Transport and Communications (MOT)			
Consultant	Joint Venture of Nippon Koei Co., Ltd. Japan and Louis Berger International Inc., USA in association with Transport Engineering Design Incorporation (TED), Vietnam			
2) Contract Packages				
Contract Packages	Major Works	Sub Packages	Package Title	Contract Amount (1000USD)
Consulting Services				
Package I	Tunnel Civil Works	Package IA	North Tunnel Section	14,724 Contracted
		Package IB	South Tunnel Section	43,256 Contracted
Package II	Road and Bridge Works	Package IIA	Lang Co Bridge Section	27,863 Contracted
		Package IIB	Southern Highway Section	4,833 Contracted
Package III	Electrical Works			3,390 Contracted
Package IV	Mechanical Works			28,608 Contracted
Package V	110/22kV Substation and 110kV Transmission Line			23,855 Contracted
Package VI	Procurement of Maintenance Vehicles			7,266 Contracted
Package VII	Infrastructure Development in the Resettlement Areas			(2,000) Estimate
				413 Contracted
Total				133,982

Distinct Points

- 6.3km long tunnel; longest highway tunnel in Southeast Asia,
- Application of New Austrian Tunneling Method (NATM),
- Application of Longitudinal Ventilation System, including Electrostatic Precipitator (EP) and Jet Fans,
- Application of integrated operation control system said SCADA (Supervisory Control And Data Acquisition), and
- Operation and Maintenance (O&M) Agency Required.

Project Schedule

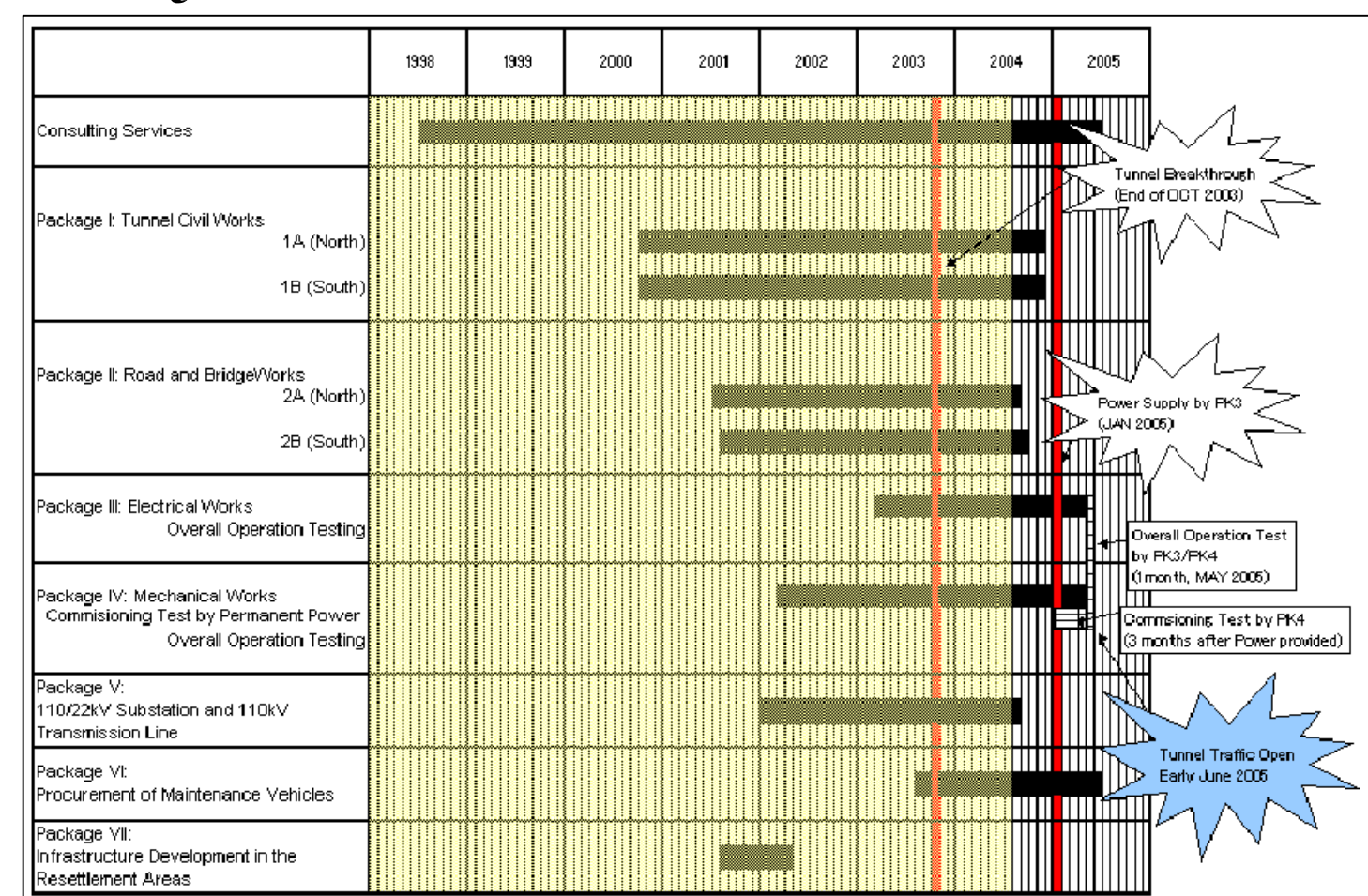

Major Feature

1. Total Project Length	12,182 m (Sta. +1+865 to Sta. 12+047) + Connection Road (Supplemental)
1) Beginning Point	Lang Co (on the existing National Highway No.1)
2) Ending Point	Lien Chieu (on National Highway No.1A)
2. Number of Traffic Lanes	2 Lanes
3. Tunnel Construction	
1) Tunnel Method	New Austrian Tunneling Method (NATM)
2) Main Tunnel	2 Lanes (3.75m wide lanes, 1.25m wide shoulders), 85.0m x 6.27m long, Lay-by at 400m intervals
3) Evacuation Tunnel	15.5m x 6.268m long
4) Vehicular and Pedestrian Cross Passages:	
	4 Vehicular/substation passages - 15.5m x 2 each
	11 Pedestrian passages - 8.1m x 2 each
5) Ventilation System:	Jet-fan Longitudinal Ventilation System with one intermediate ventilation adits (Supply and exhaust, 36.2m x 2, 1,810m long), and three Electrostatic precipitators (57.7m x 2, 153m long each)

Traffic Trend in Central Viet Nam

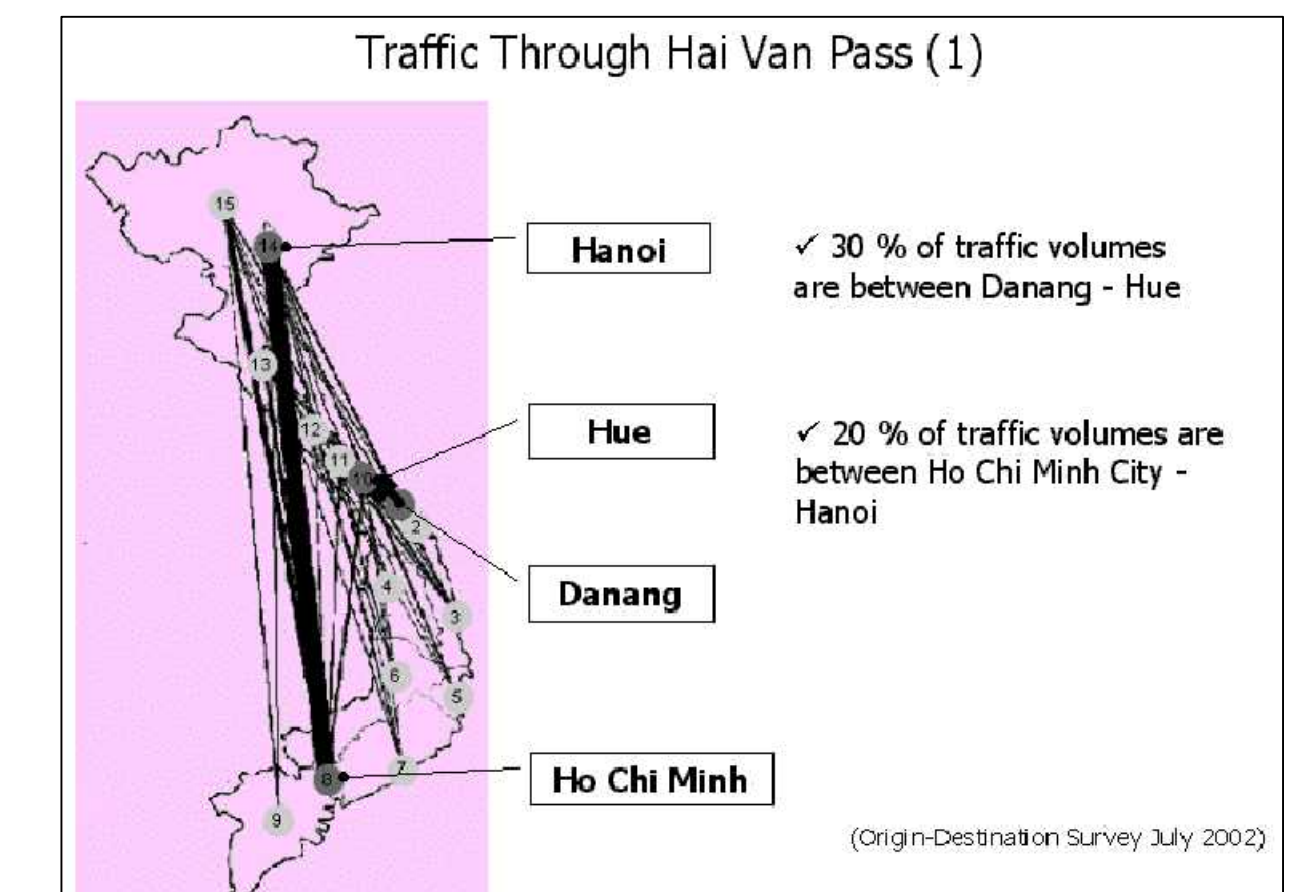

General View Lang Co Bridge

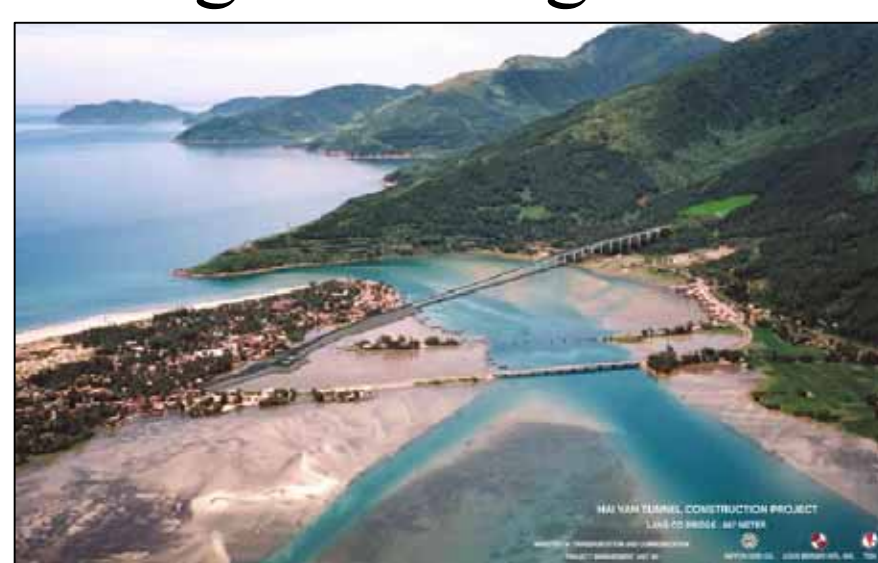

North Portal



South Portal

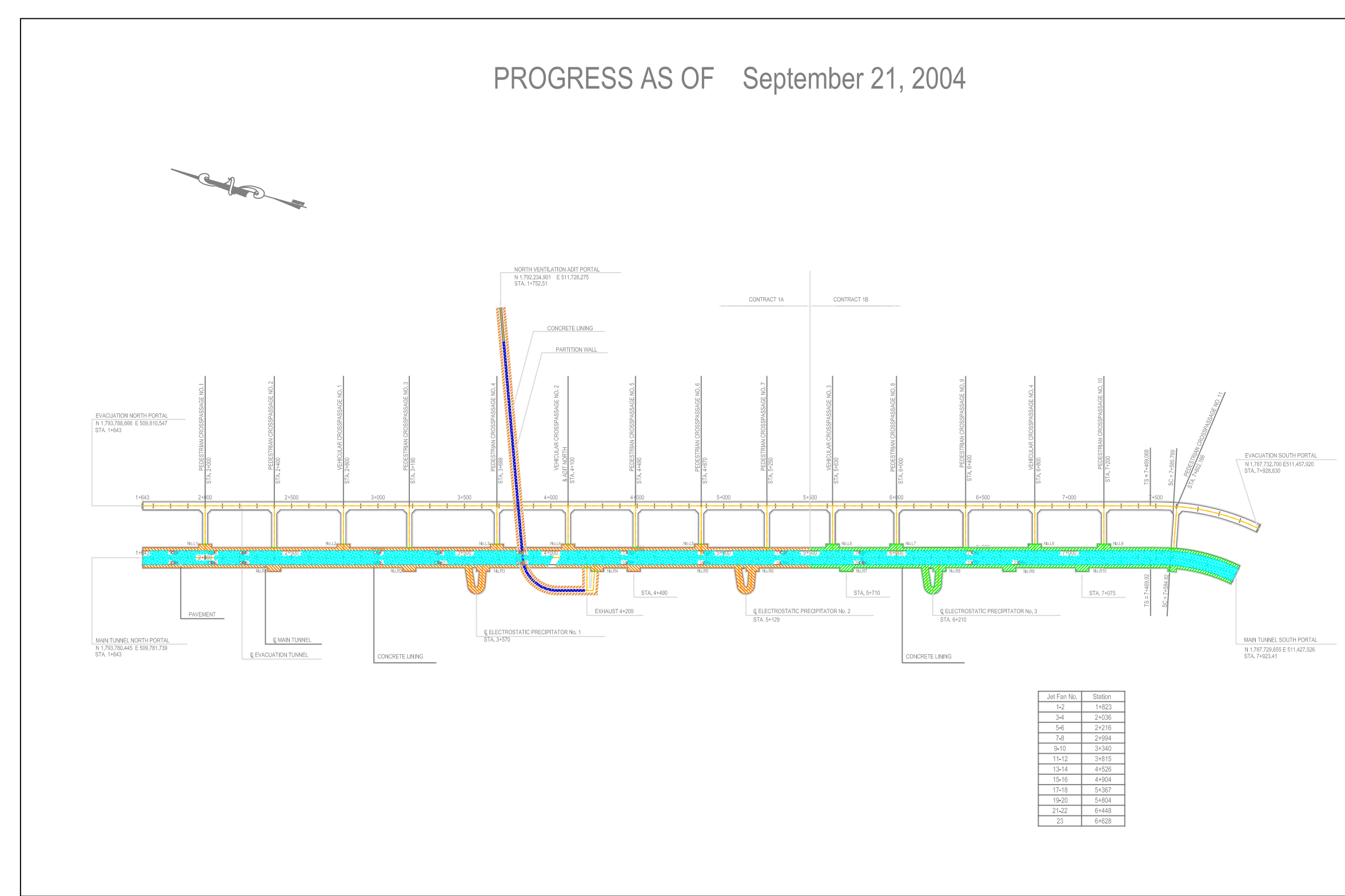
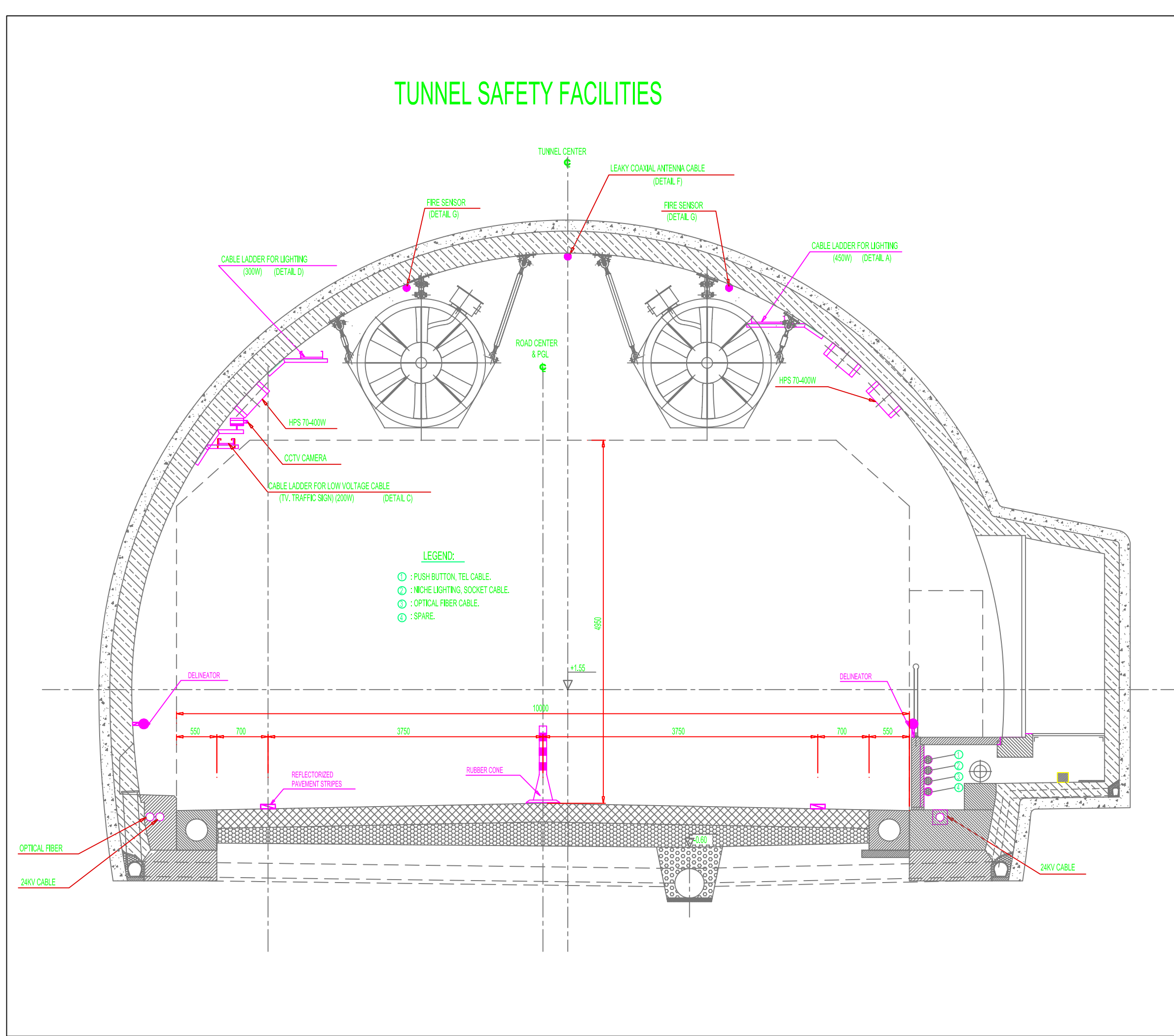

Ventilation System

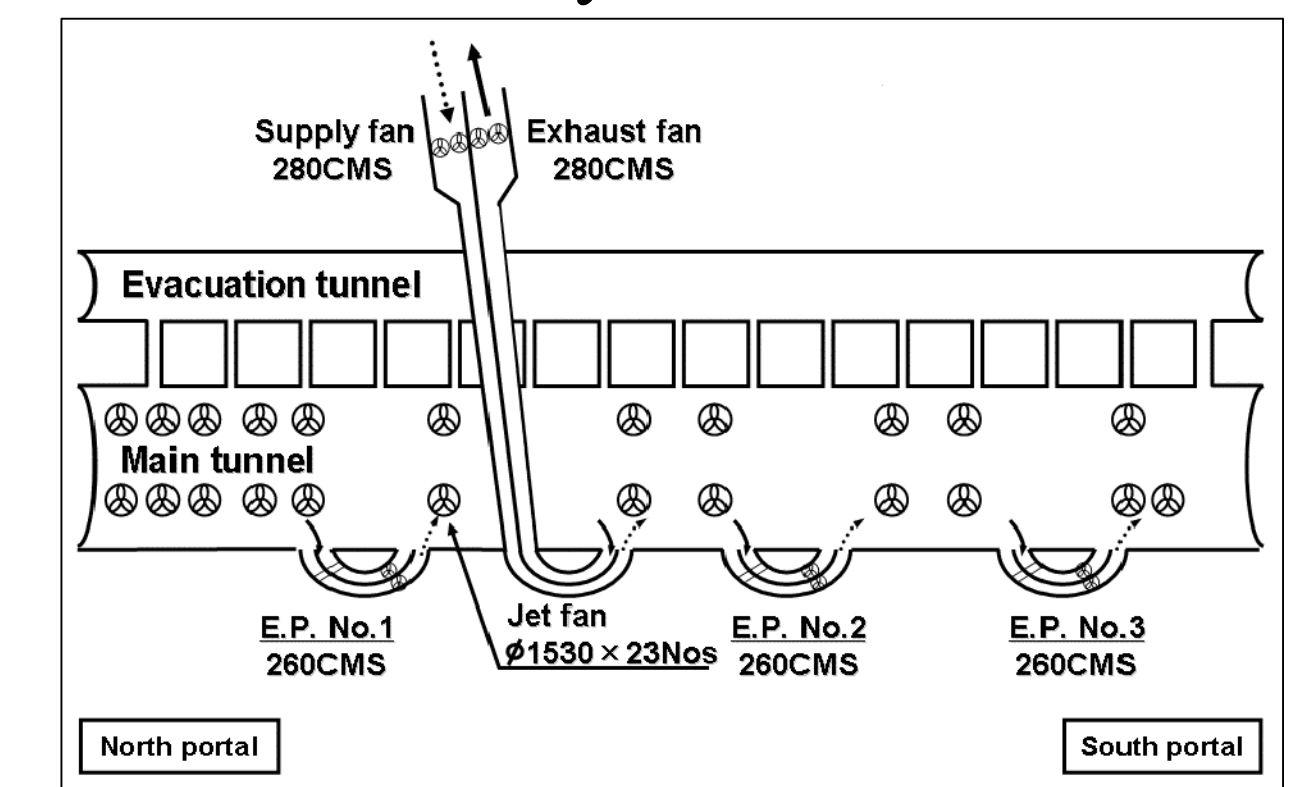

SCADA System

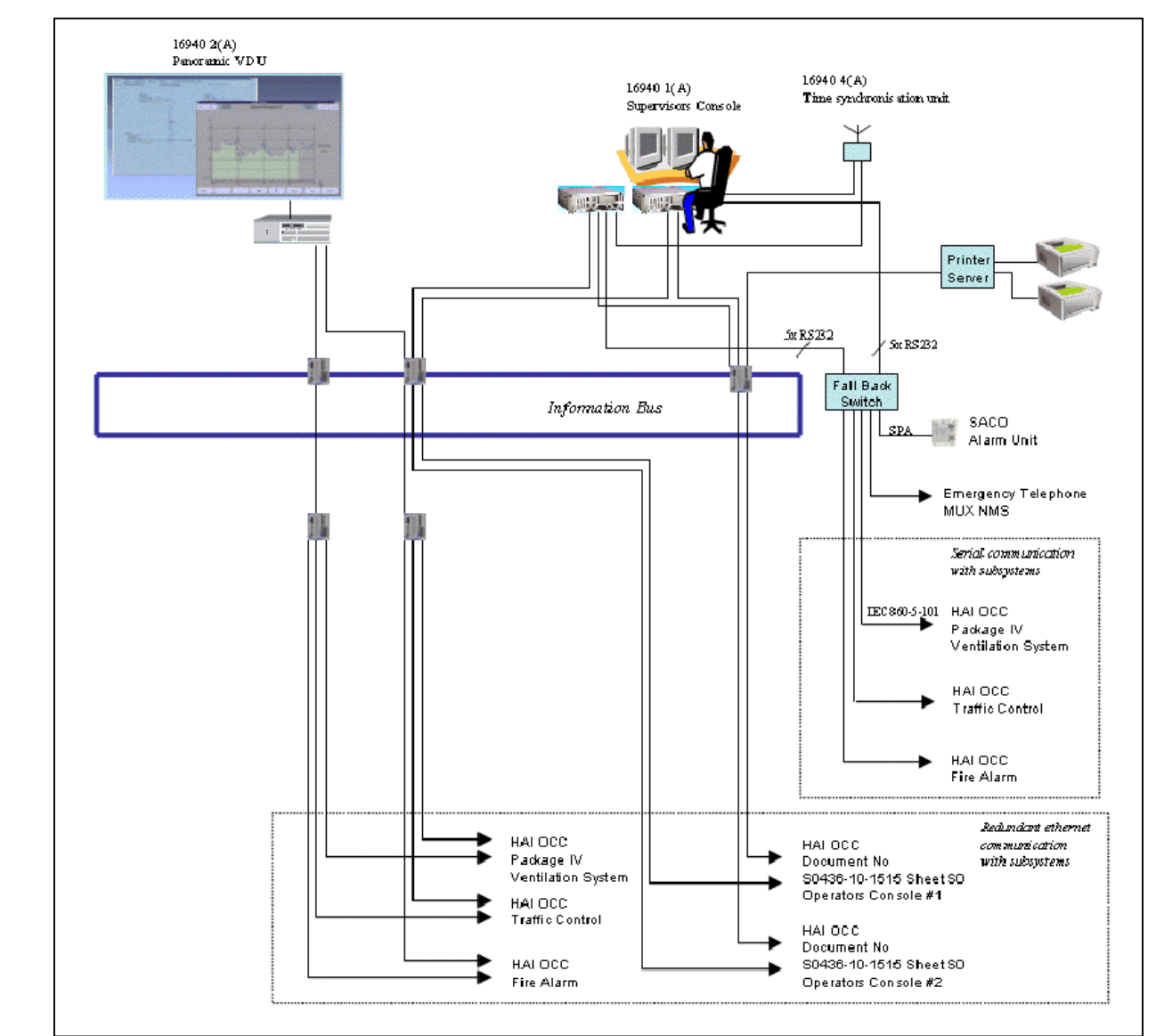

Tunnel Ventilation Facilities

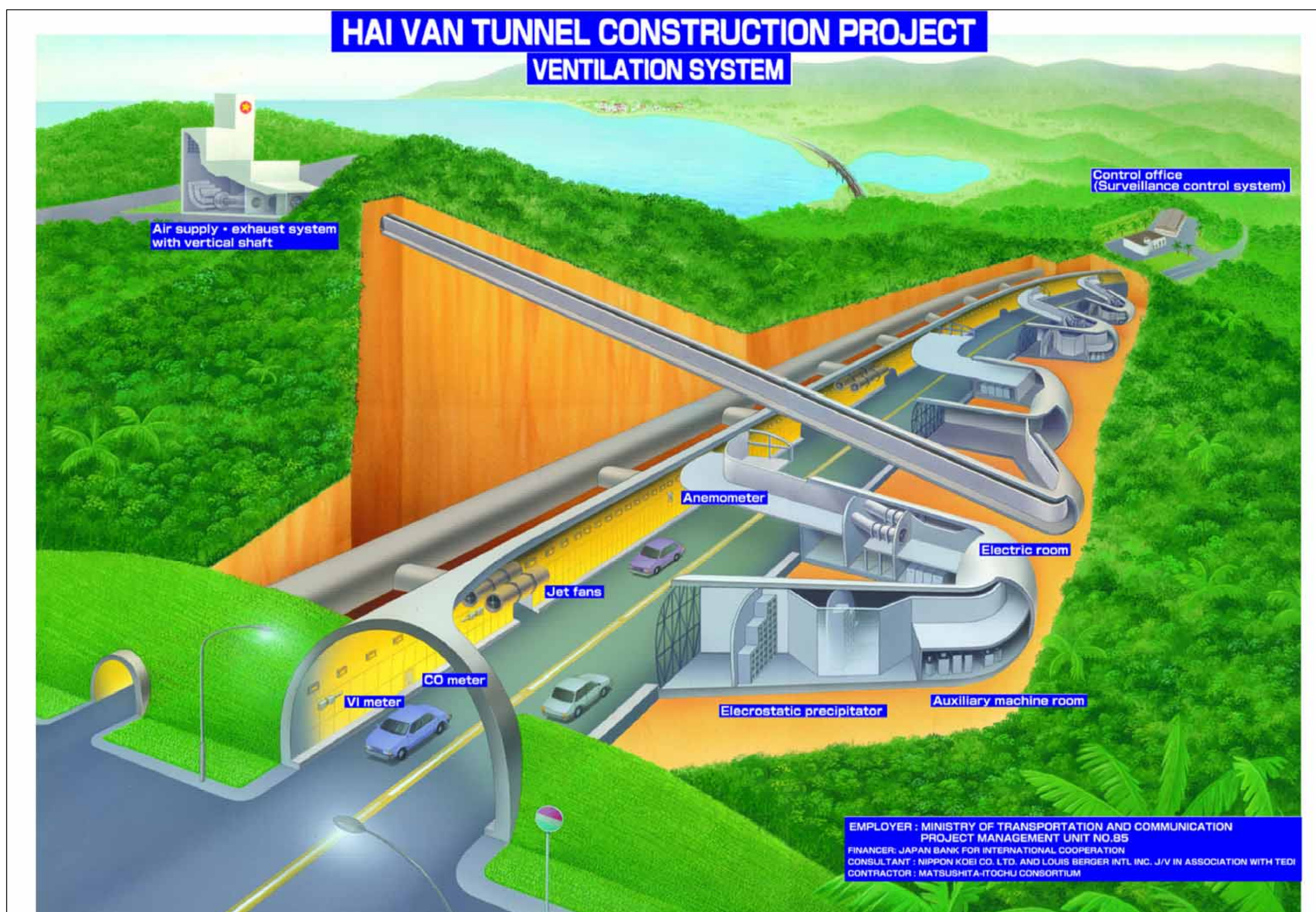

Tunnel Civil Work

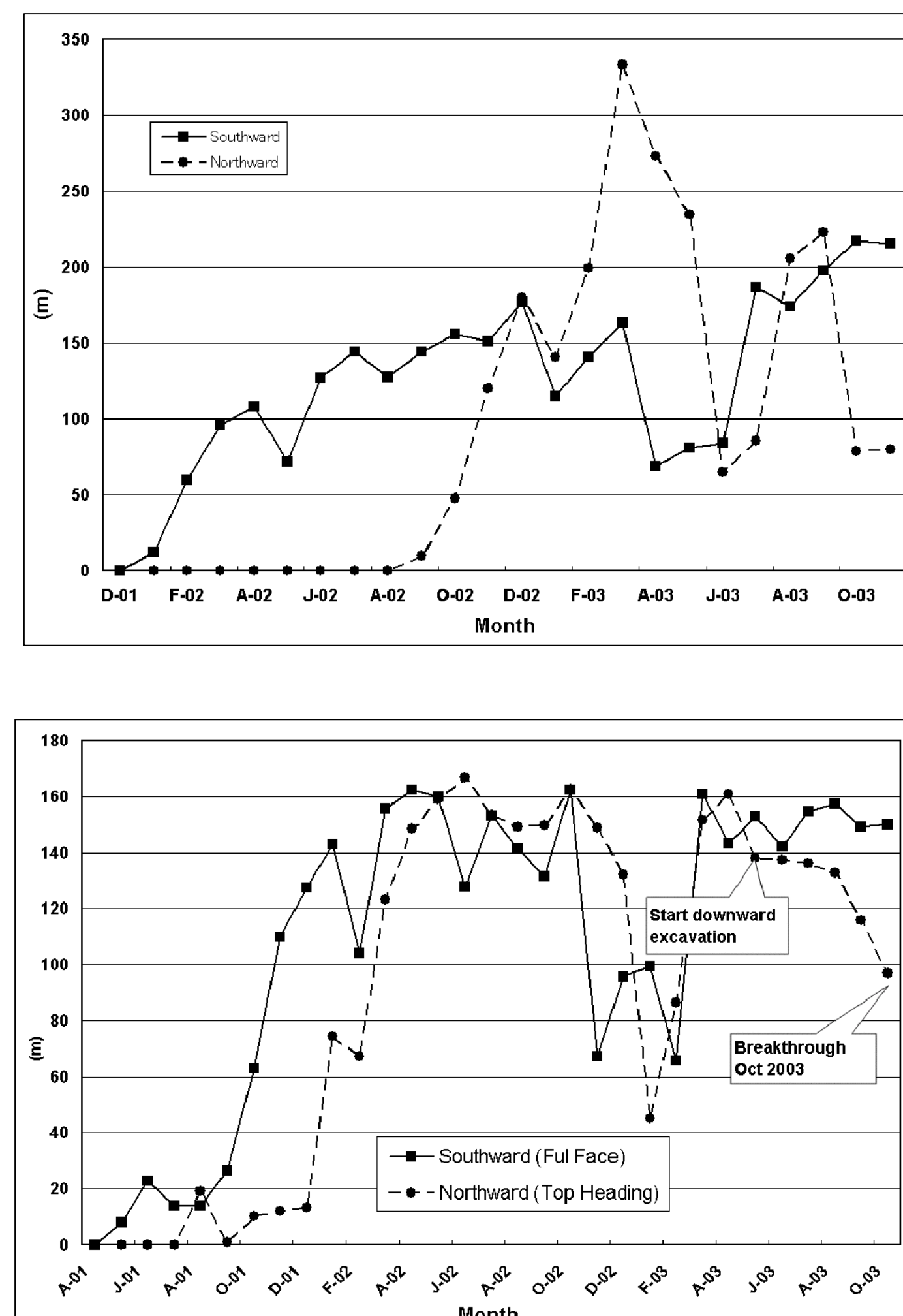

Project Management: Time Management by WBS (Sample of PK3)

